

# Trimod HE

MODULAR  
THREE-PHASE UPS  
from 10 to 80 kW

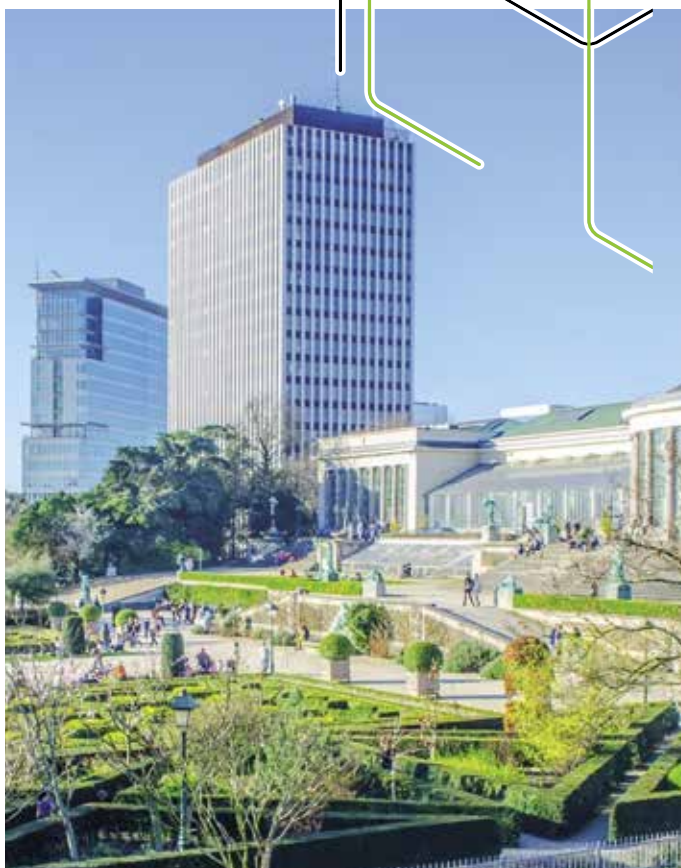

THE GLOBAL SPECIALIST  
IN ELECTRICAL AND DIGITAL BUILDING INFRASTRUCTURES

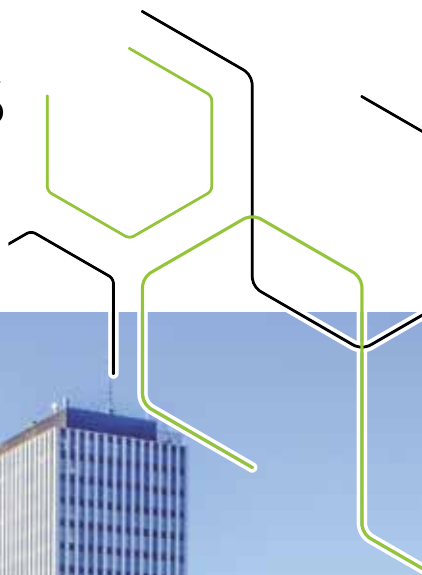

# SUSTAINABILITY

## Corporate Social Responsibility

Green management and sustainable supply chain: these concepts are part of Legrand's Corporate Social Responsibility, which is the company's commitment to drawing up a strategy and implementing it with practical actions aimed at socially responsible behaviour towards everything around it, such as people, things and environment.

CSR involves the management of human resources, the organization and division of labour and the management of natural resources. CSR aims to assess the impact that the company's actions and decisions have internally, but also externally, on the stakeholders and the environment.

### BUSINESS ECOSYSTEM

or how Legrand interacts ethically with the whole ecosystem of its activities.

### PEOPLE

or how Legrand engages with all of its employees and stakeholders.

### ENVIRONMENT

or how Legrand intends to limit the Group's environmental impact.



## Circular economy

We are committed to creating a system that involves all stakeholders to share values, objectives and actions in order to control and reduce the environmental impact of all our economic and production processes, reduce waste and environmental impact and transform what would once have been defined as «waste» into new resources. Controlling these aspects has an impact on the entire life cycle of the product, starting from the design of new concepts and new specifications for the materials the UPS is made of; this is possible through responsible design and procurement processes (so-called «green procurement»), with a strong focus on research and the use of innovative materials from the circular economy and alternative raw materials. When a product ends its life, all these materials can become high value-added resources that can be used in other production cycles.



## Digitalization

New information technologies allow us to reduce the use of several paper documents in favor of the digital format: in this way the information is always and everywhere accessible from a PC or smartphone and at the same time we can avoid the felling of many trees.

Digitization also becomes an important driver of the circular economy, since it allows the use of tools for performance data analysis and preventive diagnostics, both useful for optimizing the life cycle and durability of the product.



## Efficiency

Our R&D team is constantly working on the development of increasingly efficient UPSs that allow high and incremental performance with minimum energy dissipation; with regard to CO<sub>2</sub> emissions, we are implementing processes and products that represent an improvement in the percentage of carbon footprint compared to the past.

But efficiency is not only synonymous with high performance.

For us, efficiency also means ecodesign: this implies that the UPS is designed to be easily repaired, maintained and it's easy to separate its components.

This means increasing the durability of our UPSs and the possibility of reusing and recycling them at the end of their life.

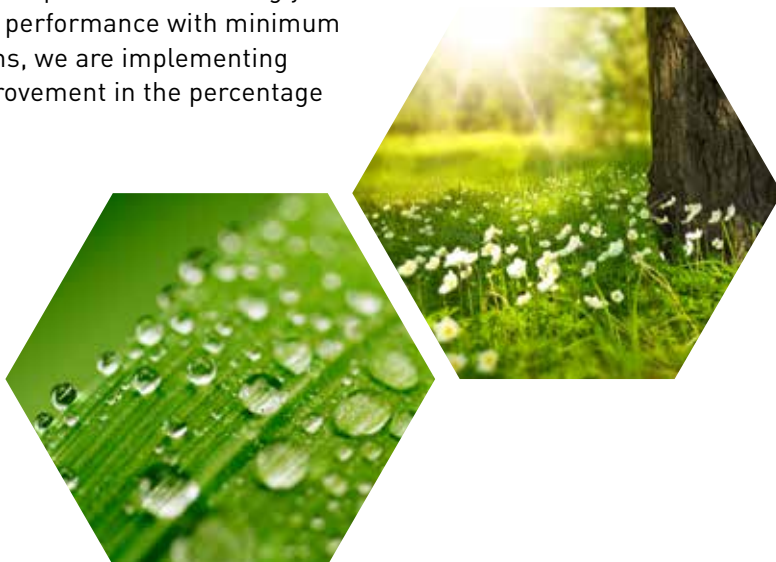

## EPD/PEP

For each product range we draw up an EPD (Environmental Product Declaration) or PEP (Profil Environnemental Produit) in line with ISO 14025: it is a declaration that is a sort of environmental photograph of the product. The EPD is drawn up according to the concept of Life Cycle Assessment: it examines the environmental impact of a product throughout its life cycle, from the development of product specifications to the choice of materials to be used and the end-of-life destination of the product itself.

# TRIMOD HE

**HIGH** performance  
**HIGH** efficiency  
**LOW** environmental impact

## DEVELOPMENTS IN TECHNOLOGY

Legrand's modular UPS know-how goes back more than 20 years, when the first ever modular UPS were introduced in 1993. Since then, continuous firmware development and research on control and hardware components have led to no stop improvements in system reliability, quality and technical performance.

Continuous research combined with modern production methods has led Legrand to offer the market a cutting-edge, top-performing product: certified efficiency up to 96% and unity power factor.

Combining high density with a structural design that optimises the space, the new TRIMOD HE systems is the ideal solution for advanced energy management and cost containment.

## CERTIFIED EFFICIENCY

up to

# 96%

**Up to 4% more efficient than the minimum values required by the European Code of Conduct for UPS VFI Elite (91.5%)\***

\* It establishes the basic principles with efficiencies regulated on the basis of the load percentages that must be followed by all the parties involved in the Energy Continuity Systems, in compliance with high energy efficiency equipment.

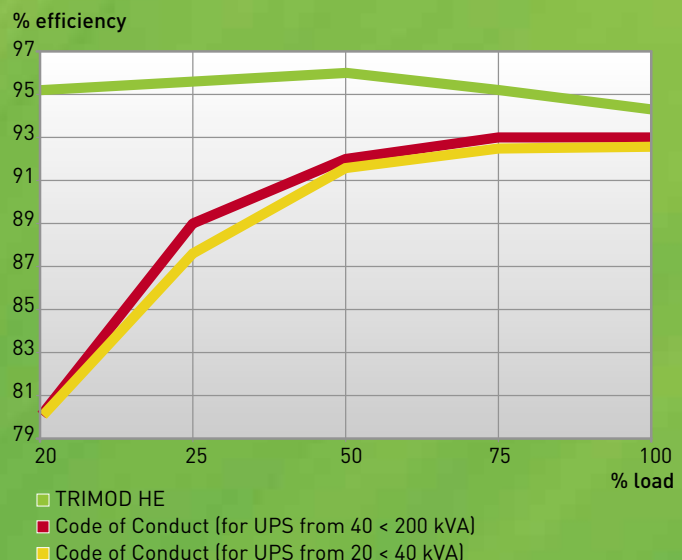





# kVA = kW

# POWER FACTOR 1

## INCREASED POWER

Thanks to their unity power factor the new TRIMOD HE UPS guarantee maximum real power; 11% more than competitor products offering 0,9 power factor, fully 25% more than those of 0.8 power factor.



# TRIMOD HE

**EXPANDABLE**  
**SCALABLE**  
**MODULAR**  
**VERSATILE**

The innovative concept of THREE-PHASE modularity, consisting of INDIVIDUAL SINGLE-PHASE MODULES which feature in the entire TRIMOD HE range, allows you to optimise power availability, increase system flexibility and reduce the total cost of ownership (TCO).

The standardised structure, consisting of smaller and lighter modules, makes it easier to transport and install the UPS systems.

All the components are self-configuring and integrate a Plug&Play connection system to make all diagnostics, maintenance and future expansion phases easier.

Because the TRIMOD HE system is versatile and programmable, it is also possible to:

- supply three independent single-phase lines, assigning a different priority to each one, in terms of operating time
- offer 4 different input/output configurations in a single cabinet: 3/3, 1/1, 3/1, 1/3
- increase the duration of the average battery life thanks to the Smart Charging System



Compact, lightweight single-phase power module (only 8.5 kg)



Easy to handle and install battery module (only 13 kg)





## REDUNDANCY ON SINGLE-PHASE LOAD

In a system with a three-phase power supply and a single-phase load there will be no power loss if one of the modules fails, as the power will be delivered by the other operational modules.

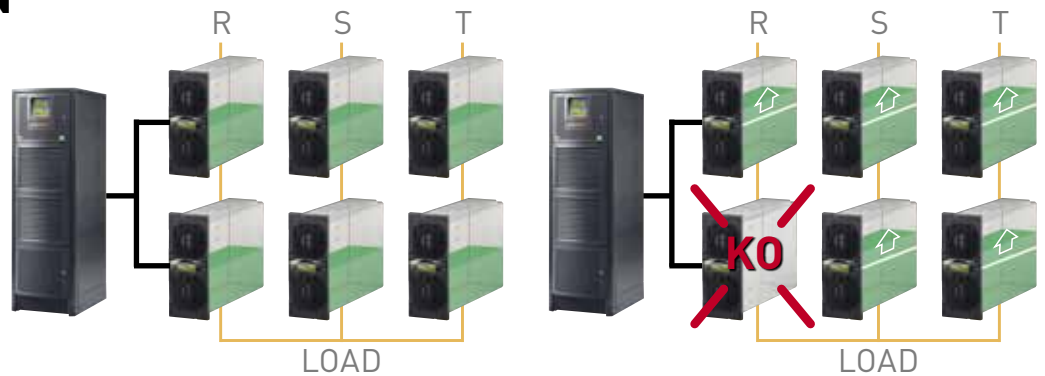

## REDUNDANCY ON THE PHASES

In a system with three independent outputs, it is possible to set the redundancy on the single phases. If one of the power modules fails, the modules in the same phase take over for the defective module.

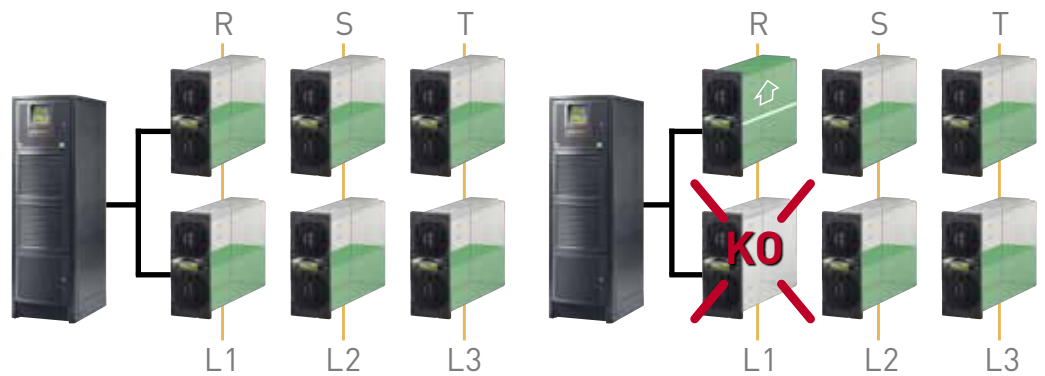

## HIGH LEVELS OF REDUNDANCY

Thanks to the construction technology of the TRIMOD HE UPS systems, you can set various redundancy levels so that maximum continuity of service is always guaranteed.



# TRIMOD HE

## POWER CABINET WITH MULTI CONTROL BOARD

In order to increase service continuity and consequently decrease failures (limit the single point of failure) the new cabinet are provided with more control modules, from 1 to a maximum of 4, so as to ensure redundancy also on control.

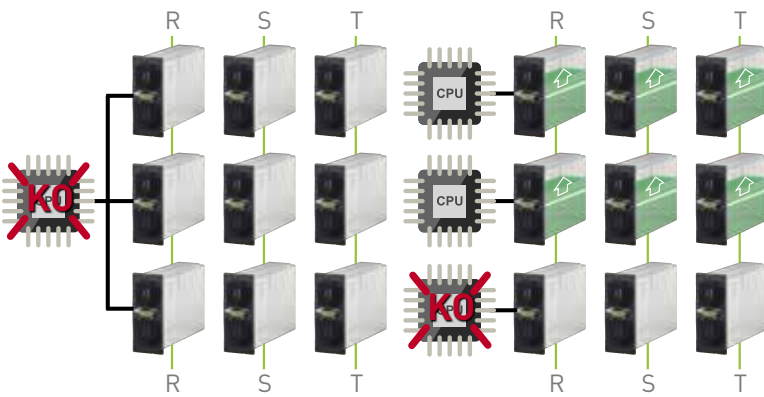

### Redundancy on the control

In UPS systems incorporating several control modules, failure of one of the control boards results in the modules it controls being switched off. However, continuity of service is assured by automatic distribution of the lost power over the other modules.

### HOT-SWAP

Thanks to the multi control board system you can replace the power modules without having to turn off the UPS.

### Separate batteries

The new multi control board cabinet, also allows you to associate each control a separate battery pack.





# POWER CABINET WITH **DUAL INPUT** FUNCTION

TRIMOD HE offers cabinet with power up to 80 kW and DUAL INPUT function. The new cabinet can be fed two AC sources is source separated: the configuration can be selected at installation time and easily obtained by removing a bridge from the input terminals.

## POSSIBLE CONFIGURATIONS

SCALABLE SOLUTION  
FROM 40 kW UP TO 80 kW



SCALABLE SOLUTION  
FROM 60 kW UP TO 80 kW



REDUNDANCY SOLUTION  
60 kW N+1



# TRIMOD HE

## Modular three-phase double conversion UPS VFI



3 104 42



3 108 71



3 108 45

### Characteristics:

- Modular three-phase UPS
- Power from 1 to 80 kVA
- On-Line double conversion VFI-SS-111
- High efficiency up to 96%
- Output factor 1
- Adaptable, redundant and scalable solutions (IN/OUT 3-1 phase configuration)
- Quick and simple maintenance
- Low environmental impact
- Diagnostics, monitoring, historical data and parameters that can be set on the screen
- Reduced foot print and dimensions
- Taller cabinet to extend backup time and standard configurations
- Multi control board function
- Dual Input Function
- Hot Swap system
- Menu available in 7 languages
- Frequency converter in 40-70Hz out 50/60Hz (selectable)
- Operations with genset
- Three independent phase outputs
- Bypass line input
- Eco Mode
- Output voltage adjustable in 1 volt steps (190÷245V)
- Bypass speed regulation
- Event log complete with date and time
- Global and historic data of each power module

Item	UPS	Power (kVA)	Back-up time (min.)	No. and Type Cabinet	Weight (kg)
3 104 42	10	11	1A	167	
3 104 43	10	21	1A	223	
3 104 44	10	35	1A	279	
3 104 02	10	49	1B	350	
3 104 45	15	13	1A	220	
3 104 46	15	21	1A	279	
3 104 07	15	29	1B	350	
3 104 47	20	9	1A	220	
3 104 48	20	14	1A	279	
3 104 13	20	20	1B	350	
3 104 17	30	8	1B	325	
3 104 19 + 3 107 63	40	8	2A	564	
3 104 20 + 2 x 3 107 63	60	10	3A	830	
3 110 08+3 104 78	80	9	2B	992	

Cabinet A h=1370, Cabinet B h=1650

Item	Accessories
3 108 69	Output module 3.4 kVA
3 108 71	Output module 5 kVA
3 108 73	Output module 6.7 kVA
3 108 51	Additional battery charger module 15 A
3 108 66	Kit of 3 power module covers
3 111 12	Seismic kit

Item	Battery accessories
3 108 54	Kit of 4 empty battery drawers
3 111 13	Kit 4 drawers battery 9 Ah
3 111 14	Kit 4 drawers battery 9 Ah long life
3 109 29	Kit for separate batteries (only for 60-80 kVA)

Item	Additional empty battery cabinet
3 108 05	16-drawer modular battery cabinet
3 108 06	20-drawer modular battery cabinet

Item	Additional battery cabinet with 9Ah batteries
3 107 60	4-drawer modular battery cabinet
3 107 61	8-drawer modular battery cabinet
3 107 62	12-drawer modular battery cabinet
3 107 63	16-drawer modular battery cabinet
3 107 64	20-drawer modular battery cabinet

NOTE: the stated backup times in minutes are estimated and may vary according to the load characteristics, operating conditions and environment.

Item	Power cabinet	Power (kVA)	No. of installable battery drawers	No. of phases	Type Cabinet	Weight (kg)
3 103 96	10	12	1-1 / 3-3 / 3-1 / 1-3	A	120	
3 103 97	10	16	1-1 / 3-3 / 3-1 / 1-3	B	155	
3 104 08	15	12	1-1 / 3-3 / 3-1 / 1-3	A	120	
3 104 03	15	16	1-1 / 3-3 / 3-1 / 1-3	B	155	
3 104 14	20	12	1-1 / 3-3 / 3-1 / 1-3	A	120	
3 104 09	20	16	3-3	B	155	
3 104 18	30	-	3-3	A	146	
3 104 15	30	12	3-3	B	181	
3 104 19	40	-	3-3	A	146	
3 104 20	60	-	3-3	A	165	
3 110 08	80	-	3-3	B	220	

Item	Power cabinets (empty)	No. of installable power modules	No. of installable battery drawers	No. of phases	Type Cabinet	Weight (kg)
3 104 22	3 x 3.4 kVA	12	1-1 / 3-3 / 3-1 / 1-3	A	85	
3 104 31	3 x 3.4 kVA	16	1-1 / 3-3 / 3-1 / 1-3	B	98	
3 104 23	3 x 5 o 6,7 kVA	12	1-1 / 3-3 / 3-1 / 1-3	A	90	
3 104 32	6 x 3.4 kVA	12	1-1 / 3-3 / 3-1 / 1-3	B	102	
3 104 33	3 x 5 o 6,7 kVA	16	1-1 / 3-3 / 3-1 / 1-3	B	102	
3 104 24	6 x 5 kVA	-	3-3	A	80	
3 104 25	6 x 5 kVA	-	1-1/3-3/1-1-3	A	84	
3 104 34	6 x 5 kVA	12	3-3	B	104	
3 104 26	6 x 6.7 kVA	-	3-3	A	80	
3 104 27	9 x 6.7 kVA	-	3-3	A	90	

Item	Power cabinets with MULTI CONTROL BOARD (empty)	No. of installable power modules	No. of installable battery drawers	No. of phases	Type Cabinet	Weight (kg)	No. of controls
3 104 68	6 x 3,4-5-6,7 kW	-	1-1 / 3-3 / 3-1 / 1-3	A	85	2	
3 104 69	6 x 5 kVA	12	3-3	B	106	2	
3 104 71	6 x 6.7 kVA	-	3-3	A	82	2	
3 104 72	9 x 6.7 kVA	-	3-3	A	91	3	
3 104 73	12 x 6.7 kVA	-	3-3	B	120	4	

Item	Additional battery cabinet with long life batteries
3 104 70	Battery cabinet for Trimod type A
3 104 78	Battery cabinet for Trimod type B



For the choice of communication accessories, see the dedicated section of this catalogue.

# TRIMOD HE

## Modular three-phase double conversion UPS VFI

### Characteristics

General Characteristics	3 103 96	3 104 03	3 104 09	3 104 15*	3 104 19	3 104 20	3 104 73
	3 103 97	3 104 08	3 104 14	3 104 18*	3 104 71	3 104 72	3 110 08
Nominal power (kVA)	10	15	20	30	40	60	80
Active power (kW)	10	15	20	30	40	60	80
Module power (kVA)	3.4	5	6.7	5	6.7	6.7	6.7
Technology	On-Line Double Conversion VFI-SS-111						
System	Modular, expandable and redundant UPS system						
<b>Input specifications</b>							
Input voltage	380, 400, 415 3F+N+PE (or 220, 230, 240 1F)			380, 400, 415 3F+N+PE			
Input frequency	45-65 Hz (43,0 ÷ 68,4 Hz)						
Input voltage range	400V +15%/-20% - 230V +15%/-20%			400V +15%/-20%			
THD Input current	< 3% ( at full load)						
Compatibility with genset	Yes						
Input Power Factor	> 0.99						
<b>Output Specifications</b>							
Output voltage	380, 400, 415 3F+N+PE (or 220, 230, 240 1F)			380, 400, 415 3F+N+PE			
Efficiency	Up to 96%						
Efficiency in Eco Mode	99%						
Nominal output frequency	50/60 Hz selectable by the user ± 0,1% (standard), ±14 % (extended)						
Peak factor	3:1						
Waveform	Sinusoidal						
Output Voltage Tolerance	±1%						
THD Output Voltage	< 1%						
Overload capacity	10 minutes at 115%, 60 seconds at 135%						
Bypass	Automatic bypass (static and electromechanical) and manual maintenance bypass						
<b>Batteries</b>							
Battery module	Plug & Play						
Battery series type/voltage	VRLA - AGM /240 Vd.c.						
Back-up time	Configurable						
Battery charger	Smart Charge Technology. 3-stage advanced cycle						
Independent battery configuration	No		Yes			Yes with KIT	
<b>Communication and management</b>							
Screen and signalling	4 20-character rows, 4 menu navigation buttons, multi-colour LED status indicator, alarms and acoustic signals						
Communication ports	2 RS232 ports, 1 logic level port, 5 floating contact ports, 1 interface slot						
Back feed protection	NC/NO auxiliary contact						
Emergency Power Off (EPO)	Yes						
Remote control	Available						
<b>Mechanical characteristics</b>							
Height A-B (mm)	1370 - 1650						
Width (mm)	414		414		414		414
Depth (mm)	628		628		628		628
Number of Installed Power Modules	3		6		9		12
Installable battery drawers (A-B)	Up to 12 - Up to 16		Up to 0 - 12		-		-
Net weight A-B (kg)	Refer to the previous page, where there are the weights of the various configurations						
<b>Ambient Conditions</b>							
Operating temperature/humidity	0 - 40°C / 0 - 95% non condensing						
Protection rating	IP20						
Noise at 1 m from the unit (dBA)	58-62						
<b>Estimated content of circular economy derived materials</b>							
<b>Recyclability rate calculated using the method described in technical report IEC/TR 62635**</b>				<b>37%</b>			
				<b>84%</b>			
<b>Certifications</b>							
Standards	EN 62040-1, EN 62040-2, EN 62040-3, EN 62040-4						
<b>Services</b>							
Installation	User executable, modular architecture with "Plug & Play" power modules and batteries						
Maintenance	User executable, availability of optional services provided by the manufacturer						
Ease of management	Advanced diagnostic functions via the touch screen display						

\* Standard configurations with 3-3 distribution (multi IN/OUT settings available upon request)

\*\* This value is based on data collected from a technological channel operating on an industrial basis. It does not pre-validate the effective use of this channel for end-of-life of this product.



# CUSTOMER SERVICES



## Reliable

Directly present in more than 70 countries and servicing its products in more than 150 countries worldwide, a team of qualified engineers is available to support your UPS system to ensure power quality and availability to the most critical loads.

## Excellent

Legrand's competitive edge lies in its ability to provide high value-added UPS systems and services for both end users and business partners.

For Legrand, creating value means coming up with solutions for lower energy consumption, but also integrating product design into the overall development process. With around 200 000 catalogue items, the Group also provides all products required for electrical and digital building installations, particularly as integrated systems, finding solutions to fit everyone's needs.

## Tailor-made

Legrand offers a complete range of specific solutions and services to meet customer requirements:

- Technical pre-sales support at the project design stage
- Factory acceptance test
- Supervision of installation, testing and commissioning, site acceptance test
- Operator training
- Site audit
- Warranty extension
- Annual maintenance contract
- Fast intervention on emergency call

## SUPPORT



### **SITE INSPECTION, INSTALLATION SUPERVISION.**

We perform a comprehensive check of the UPS environment to ensure safety and fault-free operation.

Our technical experts give manufacturer's recommendations to the site engineer or electrical contractors, and supervise the UPS installation before load power-up.

### **SITE TEST, COMMISSIONING.**

Our Service Engineers conduct rigorous site tests and full setting-up of the UPS system before going live. They also perform site acceptance tests according to your requirements.

Commissioning operations for all UPS are carried out by qualified engineers to guarantee seamless start-up. After the final handing over of the UPS system, a Test and Commissioning report is delivered to you.

## TRAINING



We offer on-site training to ensure your equipment's safe and efficient operation.

Troubleshooting courses are also available in our plants for intensive hands-on practice on UPS training equipment.

## MAINTENANCE



### **PREVENTIVE MAINTENANCE**

Electronic equipment and power systems, such as UPS, contain life-limited components and parts that must be replaced according to the manufacturer's specifications.

To ensure optimal performance and to protect your critical application from potential downtime, it is crucial to perform

preventive maintenance operations on a regular basis and replace parts when needed. Our Service Contracts include cleaning, IR thermography, measurements, functional tests, event log and power quality analysis, battery health check, hardware and software upgrades, and technical reports. A Preventive Maintenance Plan is one of the most cost-effective actions that can preserve your initial investment and ensure your business continuity.

### **CORRECTIVE MAINTENANCE, EMERGENCY CALL**

In the event of an Emergency Call, our worldwide service network, with engineers and spare-parts stocks strategically located as close as possible to your site, guarantees a fast intervention time with 24/7/365 assistance.

After connecting his laptop to your UPS, very powerful diagnostic software helps our engineer to identify the fault, thus ensuring short MTTR (Mean Time To Repair).

Corrective actions are performed such as part replacement, adjustments and upgrades to return the UPS system back to normal operation.









FOLLOW US  
ALSO ON

@ [www.ups.legrand.com](http://www.ups.legrand.com)



**World Headquarters and  
International Department**  
87045 Limoges Cedex - France  
☎ : + 33 (0) 5 55 06 87 87  
Fax : + 33 (0) 5 55 06 74 55