

UPS USER MANUAL

MANUEL DE L'UTILISATEUR DE L'UPS

UTILIZZO DELL'UPS

Index / Sommaire / Indice

ENGLISH LANGUAGE	7
1 SCOPE	8
2 SAFETY RULES AND WARNINGS	9
3 GENERAL UPS DESCRIPTION	10
3.1 TYPOLOGY.....	10
3.2 SYSTEM DESCRIPTION	10
3.2.1 Rectifier	10
3.2.2 Inverter.....	11
3.2.3 Battery and battery charger	11
3.2.4 Static bypass.....	11
3.2.5 Manual bypass	11
3.3 OPERATING STATUS.....	12
3.3.1 Normal operation	12
3.3.2 Bypass operation.....	12
3.3.3 Battery operation	13
3.3.4 Manual bypass	14
3.4 CONTROL AND OPERATION DEVICES.....	15
3.4.1 Isolators (DC input and AC output).....	15

Rev.	Descrizione Description Description	Data Date Date	Emesso Rédigé par Issued	Approvato Approuvé par Approved	Lingua Langue Language	Pagina Page Page	di Pag. Total of Pag.
C	Upgrade after FAT / Mise à niveau après FAT / Aggiornamenti dopo FAT	26.02.15	E. Biancucci <i>E. Biancucci</i>	G. Sensi <i>G. Sensi</i>	E/I	1	158
					Codice / Code / Code		
					OMD10074		

3.4.2	Emergency power off button (EPO).....	15
3.4.3	Normal/Bypass selector (SW1)	16
3.4.4	LCD control panel	16
4	FRONT PANEL	17
4.1	FUNCTION BUTTONS	17
4.2	FUNCTION OF MIMIC PANEL LED'S	18
5	HANDLING THE LCD PANEL	20
5.1	MAIN MENUS	20
5.2	MEASURE DISPLAY	21
5.3	BASIC DIAGNOSTICS	23
5.3.1	Display of alarms history.....	24
5.3.2	Alarms and operating status	25
6	SETTINGS AND ADVANCED OPERATIONS.....	27
6.1	SETTING DATE AND TIME.....	29
6.2	DISPLAY LANGUAGE SETTING.....	29
6.3	NEW BATTERY INSTALLATION.....	29
6.4	BATTERY CONFIGURATION	29
6.5	SETTING THE MODBUS PARAMETERS	31
6.6	UPS TEST.....	31
6.7	BATTERY TEST	32
6.8	SYSTEM RESET.....	32
6.9	ALARMS HISTORY RESET	33
7	SYSTEM INFORMATION.....	34
7.1	PARALLEL OPERATION INFORMATION	35
7.1.1	UPS position	35
7.1.2	Master / Slave priority	35
7.1.3	Communication bus monitoring	36
7.1.4	Parallel type	36
7.1.5	Message statistics.....	38
7.2	SERVICE INFORMATION	38
8	FAULTS AND ALARMS	39
8.1	OPERATING STATUS DEFINITION	40
8.2	TROUBLESHOOTING.....	42
	FRANÇAIS	55
1	PORTEE	56

2	RÈGLES DE SECURITE ET AVERTISSEMENTS	57
3	DESCRIPTION GÉNÉRALE DE L'UPS	58
3.1	TYPLOGIE	58
3.2	DESCRIPTION DU SYSTÈME	58
3.2.1	Redresseur	58
3.2.2	Onduleur	60
3.2.3	Batterie et chargeur de batterie.....	60
3.2.4	By-pass statique	60
3.2.5	By-pass manuel	60
3.3	ÉTAT DE FONCTIONNEMENT	61
3.3.1	Fonctionnement normal.....	61
3.3.2	Fonctionnement en by-pass	61
3.3.3	Fonctionnement sur batterie	62
3.3.4	By-pass manuel	63
3.4	DISPOSITIFS DE CONTROLE ET DE FONCTIONNEMENT	64
3.4.1	Sectionneurs d'isolation (entrée CC et sortie CA).....	64
3.4.2	Bouton d'arrêt d'urgence (EPO).....	64
3.4.3	Sélecteur normal/by-pass (SW1).....	65
3.4.4	Panneau de commande LCD	65
4	PANNEAU AVANT	66
4.1	TOUCHES DE FONCTION	66
4.2	FONCTION DES LED DU TABLEAU A SCHEMA	67
5	MANIPULATION DU PANNEAU LCD	69
5.1	MENUS PRINCIPAUX	69
5.2	AFFICHAGE DES MESURES	70
5.3	DIAGNOSTICS DE BASE	72
5.3.1	Affichage de l'historique des alarmes	73
5.3.2	Alarmes et états de fonctionnement	75
6	REGLAGES ET OPERATIONS AVANCEES	78
6.1	REGLAGE DE LA DATE ET DE L'HEURE	80
6.2	AFFICHAGE DES LANGUES DISPONIBLES	80
6.3	INSTALLATION D'UNE NOUVELLE BATTERIE	80
6.4	CONFIGURATION DE LA BATTERIE	80
6.5	REGLAGE DES PARAMETRES MODBUS	82
6.6	TEST DE L'UPS	82

6.7	TEST DE LA BATTERIE	84
6.8	RÉINITIALISATION DU SYSTÈME	84
6.9	REMISE A ZERO DE L'HISTORIQUE DES ALARMES	86
7	INFORMATIONS SYSTÈME	88
7.1	INFORMATIONS SUR LE FONCTIONNEMENT EN PARALLELE	89
7.1.1	Position de l'UPS	89
7.1.2	Hiérarchie maître / esclave	89
7.1.3	Surveillance du bus de communication	91
7.1.4	Type de système parallèle	91
7.1.5	Statistiques relatives aux messages	93
7.2	INFORMATIONS RELATIVES À L'ENTRETIEN	93
8	DEFAUTS ET ALARMES	94
8.1	DEFINITION DES ETATS DE FONCTIONNEMENT	95
8.2	DEPANNAGE	97
	LINGUA ITALIANA	110
1	APPLICABILITÀ	111
2	REGOLE E AVVERTENZE DI SICUREZZA	112
3	DESCRIZIONE GENERALE DELL'UPS	113
3.1	TIPOLOGIA	113
3.2	DESCRIZIONE DEL SISTEMA	113
3.2.1	Raddrizzatore	113
3.2.2	Inverter	114
3.2.3	Batteria e carica batteria	114
3.2.4	Bypass statico	114
3.2.5	Bypass manuale	114
3.3	STATI DI FUNZIONAMENTO	115
3.3.1	Funzionamento normale	115
3.3.2	Funzionamento da bypass	115
3.3.3	Funzionamento da batteria	116
3.3.4	Bypass manuale	117
3.4	COMANDI E ORGANI DI MANOVRA	118
3.4.1	Sezionatori (ingresso DC e uscita AC)	118
3.4.2	Pulsante di arresto di emergenza (EPO)	118
3.4.3	Selettore Normale/Bypass (SW1)	119
3.4.4	Pannello di comando LCD	119

4	PANNELLO FRONTALE	120
4.1	TASTI FUNZIONE	120
4.2	FUNZIONE DEI LED DEL SINOTTICO	121
5	GESTIONE DEL PANNELLO LCD	123
5.1	MENU PRINCIPALI	123
5.2	VISUALIZZAZIONE DELLE MISURE	124
5.3	DIAGNOSTICA DI BASE	126
5.3.1	Visualizzazione dello storico allarmi	127
5.3.2	Lista degli allarmi e degli stati	128
6	IMPOSTAZIONI E OPERAZIONI AVANZATE	130
6.1	IMPOSTAZIONE DI DATA E ORA	132
6.2	IMPOSTAZIONE LINGUA DISPLAY	132
6.3	INSTALLAZIONE NUOVA BATTERIA	132
6.4	CONFIGURAZIONE BATTERIA	132
6.5	IMPOSTAZIONE PARAMETRI MODBUS	134
6.6	TEST DELL'UPS	134
6.7	TEST DI BATTERIA	135
6.8	RESET DEL SISTEMA	135
6.9	RESET STORICO ALLARMI	137
7	INFORMAZIONI SUL SISTEMA	138
7.1	INFORMAZIONI SUL FUNZIONAMENTO IN PARALLELO	139
7.1.1	Posizione dell'UPS	139
7.1.2	Priorità Master / Slave	139
7.1.3	Controllo bus di comunicazione	140
7.1.4	Tipo di parallelo	140
7.1.5	Statistiche messaggi	142
7.2	INFORMAZIONI RELATIVE ALL'ASSISTENZA	142
8	GUASTI E ALLARMI	143
8.1	DEFINIZIONE DEGLI STATI DI FUNZIONAMENTO	144
8.2	CONTROLLO DEI GUASTI	146

Index of pictures / Index des illustrations / Indice delle figure

<i>Picture 1 – Block diagram</i>	10
<i>Picture 2 – Normal operation</i>	12

<i>Picture 3 – Load supplied by bypass</i>	12
<i>Picture 4 – Battery operation</i>	13
<i>Picture 5 – Manual bypass</i>	14
<i>Picture 6 – UPS front panel</i>	17
<i>Picture 7 – UPS mimic panel</i>	18
<i>Picture 8 – Structure of MEASURES menu (1 of 2)</i>	21
<i>Picture 9 – Structure of MEASURES menu (2 of 2)</i>	22
<i>Picture 10 – Structure of ALARMS menu</i>	23
<i>Picture 11 – Structure of SPECIAL menu</i>	27
<i>Picture 12 – Structure of INFO menu</i>	34
<i>Illustration 1 – Schéma de bloc</i>	58
<i>Illustration 2 – Fonctionnement normal</i>	61
<i>Illustration 3 – Charge alimentée par by-pass</i>	61
<i>Illustration 4 – Fonctionnement sur batterie</i>	62
<i>Illustration 5 – By-pass manuel</i>	63
<i>Illustration 6 – Panneau avant de l'UPS</i>	66
<i>Illustration 7 – Tableau à schéma de l'UPS</i>	67
<i>Illustration 8 – Structure du menu MEASURES (MESURES) (1 sur 2)</i>	70
<i>Illustration 9 – Structure du menu MEASURES (MESURES) (2 sur 2)</i>	71
<i>Illustration 10 – Structure du menu ALARMS (ALARMES)</i>	72
<i>Illustration 11 – Structure du menu SPECIAL</i>	78
<i>Illustration 12 – Structure du menu INFO</i>	88
<i>Figura 1 – Schema a blocchi</i>	113
<i>Figura 2 – Funzionamento normale</i>	115
<i>Figura 3 – Carico alimentato da bypass</i>	115
<i>Figura 4 – Funzionamento da batteria</i>	116
<i>Figura 5 – By-pass manuale</i>	117
<i>Figura 6 – Pannello frontale UPS</i>	120
<i>Figura 7 – Sinottico UPS</i>	121
<i>Figura 8 – Struttura menu MISURE (1 di 2)</i>	124
<i>Figura 9 – Struttura menu MISURE (2 di 2)</i>	125
<i>Figura 10 – Struttura menu allarmi</i>	126
<i>Figura 11 – Struttura menu SPECIALE</i>	130
<i>Figura 12 – Struttura menu INFO</i>	138

ENGLISH LANGUAGE

1 SCOPE

The instructions contained in this section of the manual apply to the UPS systems indicated below.

- KEOR HP 60kVA
- KEOR HP 80kVA
- KEOR HP 100kVA
- KEOR HP 125kVA
- KEOR HP 160kVA
- KEOR HP 200kVA
- KEOR HP 250kVA
- KEOR HP 300kVA
- KEOR HP 400kVA
- KEOR HP 500kVA
- KEOR HP 600kVA
- KEOR HP 800kVA



Storing documentation

This manual and any other supporting technical documentation relating to the product must be stored and made accessible to personnel in the immediate vicinity of the UPS.



Further information

In the event that the information provided in this manual is not sufficiently exhaustive, please contact the manufacturer of the device, whose details are available in the "Contacts" section.

2 SAFETY RULES AND WARNINGS



Injury hazard due to electric shock!

Always respect all the safety instructions and, in particular:

- any work on the unit must be carried out by qualified personnel;
- internal components can only be accessed after disconnecting the device from supply sources;
- always use protective devices designed for each type of activity;
- the instructions contained in the manuals must be strictly followed.



Injury hazard due to device failure

Potentially hazardous situations may arise in case of UPS failure.

- Do not use the device if visibly damaged.
- Maintain the device regularly to identify possible failure.



Possible device damage

Whenever work is carried out on the device, make sure all actions are taken in order to avoid electrostatic discharges which might damage the electronic components of the system.



Read the technical documentation

Before installing and using the device, make sure you have read and understood all the instructions contained in the present manual and in the technical supporting documentation.

3 GENERAL UPS DESCRIPTION

The UPS use IGBT technology with a high changeover frequency in order to allow a low distortion of the current re-injected into the supply line, as well as high quality and stability of output voltage. The components used assure high reliability, very high efficiency and maintenance easiness.

3.1 TYPOLOGY

The UPS are on-line, double conversion; the inverter included in the UPS always supplies energy to the load, whether mains is available or not (according to the battery autonomy time).

This configuration guarantees the best service to the User, as it supplies clean power uninterruptedly, ensuring voltage and frequency stabilization at nominal value. Thanks to the double conversion, it makes the load completely immune from micro-interruptions and from excessive mains variations, and prevents damage to critical loads (Computer - Instrumentation - Scientific equipment etc.).



Output voltage present

The line connected to the UPS output is energized even during mains failure, therefore in compliance with the prescriptions of IEC EN62040-1-2, the installer will have to identify the line or the plugs supplied by the UPS making the User aware of this fact.

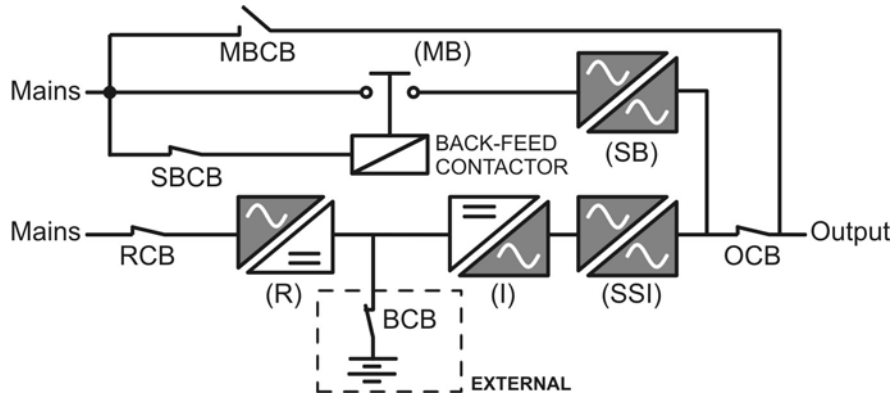

Picture 1 – Block diagram

3.2 SYSTEM DESCRIPTION

3.2.1 Rectifier

It converts the three-phase voltage of the AC mains into continuous DC voltage.

It uses a three-phase fully-controlled IGBT bridge with a low harmonic absorption.

The control electronics uses a 32 bit μ P of latest generation that allows to reduce the distortion of the current absorbed by mains (THDi) to less than 5%. This ensures that the rectifier does not distort the supply mains, with regard to the other loads. It also avoids cable overheating due to the harmonics circulation.

The rectifier is so sized as to supply the inverter at full load and the battery at the maximum charging current.

3.2.2 Inverter

It converts the direct voltage coming from the rectifier or from the DC battery into alternating AC voltage stabilized in amplitude and frequency.

The inverter uses IGBT technology with a high changeover frequency of approximately 15 kHz.

The control electronics uses a 32 Bit μ P of latest generation that, thanks to its processing capability, generates an excellent output sine-wave.

Moreover, the fully digital control of the output sine-wave allows to achieve high performances, among which a very low voltage distortion even in presence of high-distorting loads.

3.2.3 Battery and battery charger

The battery is installed outside the UPS. It is generally housed in an external battery cabinet.

The battery charger logic is completely integrated in the rectifier's control electronics.

The battery is charged, according to the DIN 41773 Standard, every time it has been partially or completely discharged. When its full capacity is restored, it is kept floating so as to compensate for any autodischarge.

3.2.4 Static bypass

The Static Bypass allows to transfer the load between Inverter and Emergency Mains, and vice-versa, in a very short time, and uses SCR's as power commutation elements.

3.2.5 Manual bypass

The Manual Bypass is used to cut off the UPS completely, supplying the load directly from the input mains in case of maintenance or serious failure.



Follow the procedures contained in the manual

The sequence of manual bypass switching and return must be carried out with respect to the procedure indicated in the installation and start-up section. The manufacturer cannot accept responsibility for damages arising from incorrect operation.



External manual bypass

In the UPS systems of the KEOR HP 400-800kVA, the manual bypass isolator is optional and outside the unit.

3.3 OPERATING STATUS

The UPS has four different operating modes, as described below:

- Normal operation
- Bypass operation
- Battery operation
- Manual bypass

3.3.1 Normal operation

During normal operation all the circuit breakers/isolators are closed, except for MCB (maintenance bypass).

The rectifier is supplied by the AC three-phase input voltage which, on its turn, feeds the inverter and compensates mains voltage as well as load variations, keeping the DC voltage constant. At the same time, it keeps the battery charged (floating or boost charge depending on the battery type). The inverter converts the DC voltage into an AC sine-wave with stabilized voltage and frequency, and also supplies the load via its static switch SSI.

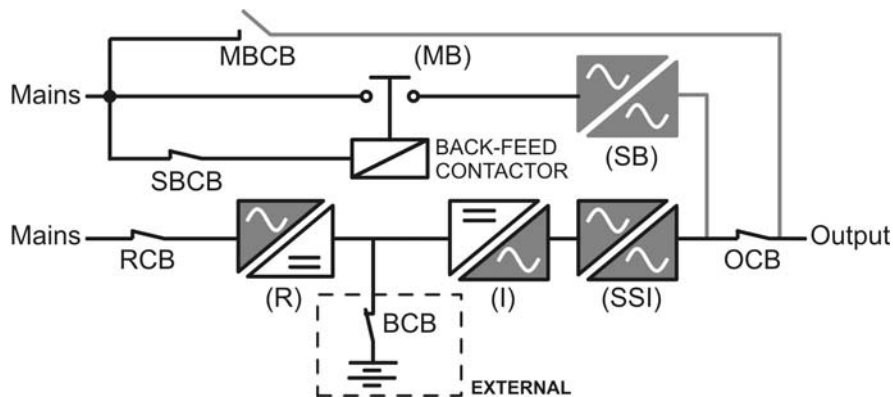

Picture 2 – Normal operation

3.3.2 Bypass operation

The load can be switched to bypass either automatically or manually. The manual changeover is due to the BYPASS SWITCH which forces the load to bypass. In case of failure of the bypass line, the load is switched back to inverter without interruption.

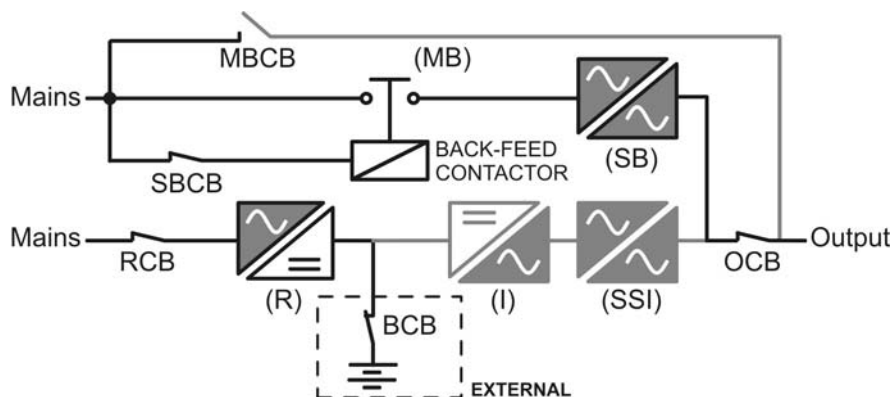

Picture 3 – Load supplied by bypass

3.3.3 Battery operation

In case of power failure or rectifier fault, the battery feeds the inverter without interruption. The battery voltage drops based on the amplitude of the discharging current. The voltage drop has no effect on the output voltage, which is kept constant by changing the PWM modulation. An alarm is activated when the battery is near the minimum discharge value.

In case the supply is restored before the battery is completely discharged, the system will be switched back to normal operation automatically. In the opposite case, the inverter shuts down and the load is switched to the bypass line (bypass operation). If the bypass line is not available or is out of tolerance, the loads supply is interrupted as soon as the battery reaches the discharge limit threshold (*black-out*).

As soon as the supply is restored, the rectifier will recharge the battery. In the standard configuration, the loads are supplied again via static switch SSB when mains is available again. The inverter is restarted when the battery has partially restored its capacity.

The system restart from the *black-out* condition can be customized based on the requirements of the plant, in three different modes:

- Bypass → loads are supplied as soon as the bypass line is available (factory configuration).
- Inverter → loads are supplied by the inverter (even if the bypass line is available) when the battery voltage has reached a programmed threshold, after the rectifier restart.
- Man. Inverter → the output supply is NOT restored automatically. The system requires a confirmation to restart which can only be done manually by the user via the front panel.

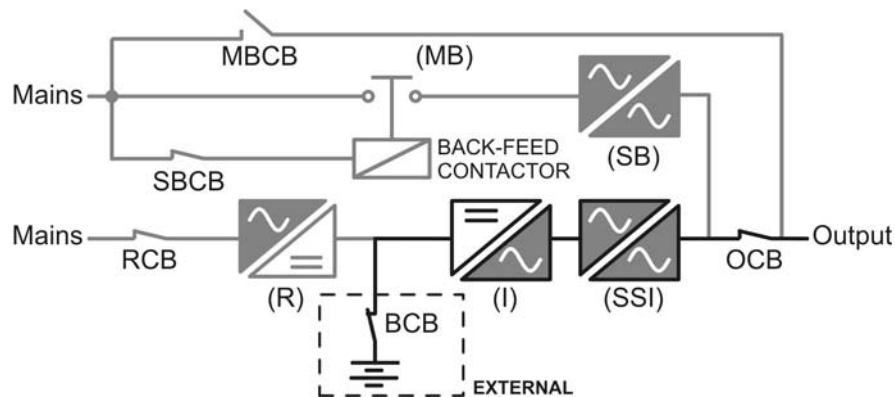

Picture 4 – Battery operation

3.3.4 Manual bypass

The manual bypass operation is necessary whenever the UPS functionality is tested, or during maintenance or repair work.

During the manual bypass due to repair or maintenance, the UPS is completely shut down and the load is directly supplied by the bypass line.



Follow the procedures contained in the manual

The sequence of manual bypass switching and return must be carried out with respect to the procedure indicated in the installation and start-up section. The manufacturer cannot accept responsibility for damages arising from incorrect operation.



External manual bypass

In the UPS systems of the KEOR HP 400-800kVA, the manual bypass isolator is optional and outside the unit.

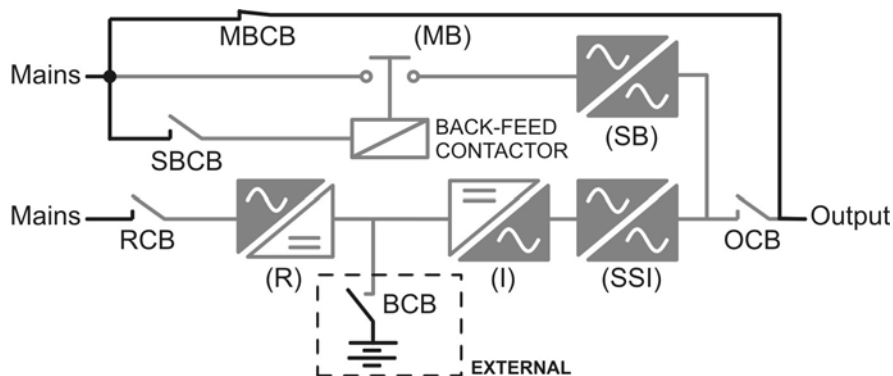

Picture 5 – Manual bypass

3.4 CONTROL AND OPERATION DEVICES

The control and operation devices of the UPS are indicated below:

- AC isolator on rectifier input (RCB)
- AC contactor on bypass line input
- Isolator on UPS output (OCB)
- Manual bypass isolator (MBCB) – **Optional external for KEOR HP 400-800kVA**
- Battery Isolator / Circuit breaker (BCB) – **Optional, outside the UPS**
- Emergency power off button (EPO)
- Normal/Bypass selector (SW1)
- LCD control panel



Check the personnel training

The use of the operation and control devices of the UPS is intended for authorized personnel only. We recommend to check the training of the personnel responsible for the use and maintenance of the system.

3.4.1 Isolators (DC input and AC output)

The isolators provided on the UPS are used to isolate the power components of the device from the AC supply line, from the storage battery and from the loads.



Voltage present on terminals

The isolators do not isolate the UPS completely, where the AC line and battery voltages are still present on the terminals. Before carrying out any maintenance on the unit:

- Isolate the device completely by operating the external circuit breakers;
- Wait at least 5 minutes in order to allow the capacitors to discharge.

3.4.2 Emergency power off button (EPO)

The emergency power off button is used to disconnect the UPS output immediately, interrupting the loads supply. It also shuts down the inverter.



Press the button only in case of real emergency

The components of the system are subject to a high stress when the emergency power off button is pressed under load presence.

- Use the emergency power off button only in case of real emergency.



External manual bypass

In the UPS systems of the KEOR HP 400-800kVA, the local emergency power off button is not provided.

The UPS is also provided with two terminals (Eac1-Eac2) on which a remote emergency power off contact may be connected.

The presence of voltage on the output terminals is restored as soon as the power off button, or the remote contact, is brought back to the initial position.



Supply reset

Reset the output supply only when the causes which led to the emergency shutdown have been eliminated and you are sure that there is no hazard to persons and things.

3.4.3 Normal/Bypass selector (SW1)

The Normal/Bypass selector is installed in the control panel and is only accessible by opening the front door. It is generally used during the manual bypass procedure, when it is necessary to isolate the UPS for maintenance or repair.



Follow the procedures contained in the manual

The Normal/Bypass selector shall only be operated in accordance with the procedures specified in the installation and start-up section. The manufacturer cannot accept responsibility for damages arising from incorrect operation.

3.4.4 LCD control panel

The control panel of the UPS is used in order to:

- Check the operating parameters of the device
- Check the alarms present
- Access the event log
- Display the information on the device
- Modify the operating parameters

The menu which allows to change the parameters is password-protected in order to prevent access to unauthorized personnel.

4 FRONT PANEL

The front panel of the UPS, consisting of a double row alphanumeric display plus 5 function keys, allows the complete monitoring of the UPS status.

The mimic flow helps to understand the operating status of the UPS.

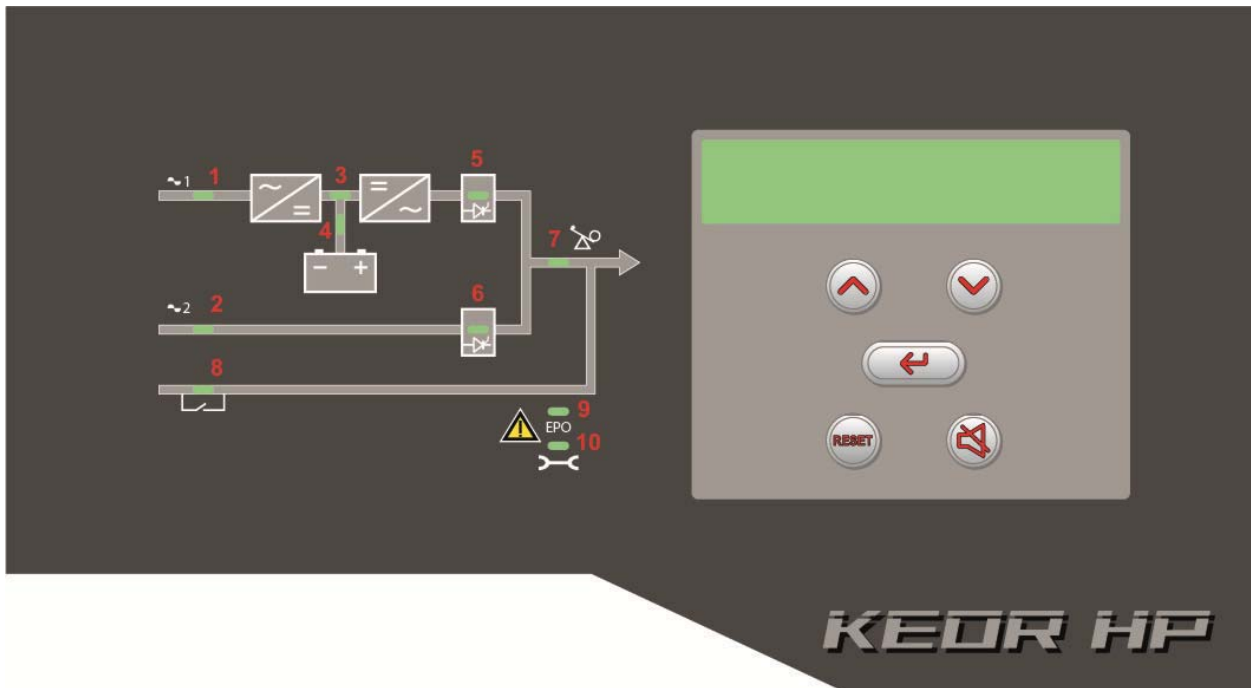

Picture 6 – UPS front panel

4.1 FUNCTION BUTTONS







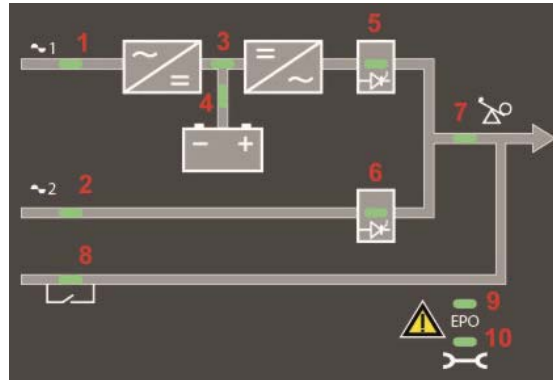







































The front panel of the UPS is provided with 5 buttons whose functions are indicated in the following table:

Button	Assigned functions
	<ul style="list-style-type: none"> ➤ Scrolls up the menus ➤ Increases the values by one unit ➤ Selects a value
	<ul style="list-style-type: none"> ➤ Scrolls down the menus ➤ Decreases the values by one unit ➤ Selects a value
	<ul style="list-style-type: none"> ➤ Selects a menu ➤ Confirms changes
	<ul style="list-style-type: none"> ➤ Silences the buzzer (activated due to an alarm or a failure)
	<ul style="list-style-type: none"> ➤ Returns to the previous menu

4.2 FUNCTION OF MIMIC PANEL LED'S



Picture 7 – UPS mimic panel

LED 1	 GREEN	AC line on rectifier input within tolerance
	   GREEN	Wrong phase rotation
	 OFF	AC mains failure on rectifier input
LED 2	 GREEN	AC bypass line within tolerance
	   GREEN	Wrong phase rotation
	 OFF	AC bypass line out of tolerance AC bypass line failure
LED 3	   GREEN	Rectifier off or faulty
	 RED	DC voltage out of tolerance
	 GREEN	Rectifier on and DC voltage within tolerance
LED 4	 GREEN	circuit breaker BCB closed and battery charging
	   GREEN	Battery discharging or under TEST
	   ORANGE	Circuit breaker BCB open
	 RED	Battery fault (following a battery test)
	 OFF	Battery not available
LED 5	 GREEN	Inverter voltage within tolerance and static switch closed
	   GREEN	Inverter overload or short-circuit
	 OFF	Inverter off or voltage out of tolerance
LED 6	   ORANGE	Re-transfer blocked
	 ORANGE	Static bypass switch closed
	 OFF	Static bypass switch open
LED 7	 GREEN	Output circuit breaker OCB closed
	 OFF	Output circuit breaker OCB open
LED 8	 ORANGE	Manual bypass switch MBCB closed
	 OFF	Manual bypass switch MBCB open
LED 9	 RED	Emergency power off (EPO) activated
	 OFF	Normal operation
LED 10	   ORANGE	Maintenance request (slow flashing)
	   ORANGE	Critical alarm (fast flashing)
	 OFF	Normal operation

5 HANDLING THE LCD PANEL

5.1 MAIN MENUS

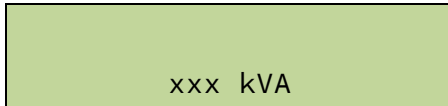

Main screen (nominal power of the UPS)

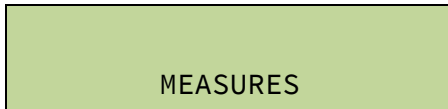

UPS measures regarding basic parameters (voltage, current, etc.)



UPS operating status, possible alarms present and alarms history



Setting of parameters and special functions

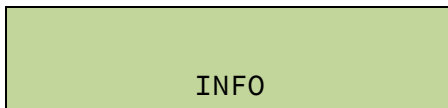

General information regarding the UPS

5.2 MEASURE DISPLAY

The MEASURES menu is structured as follows:

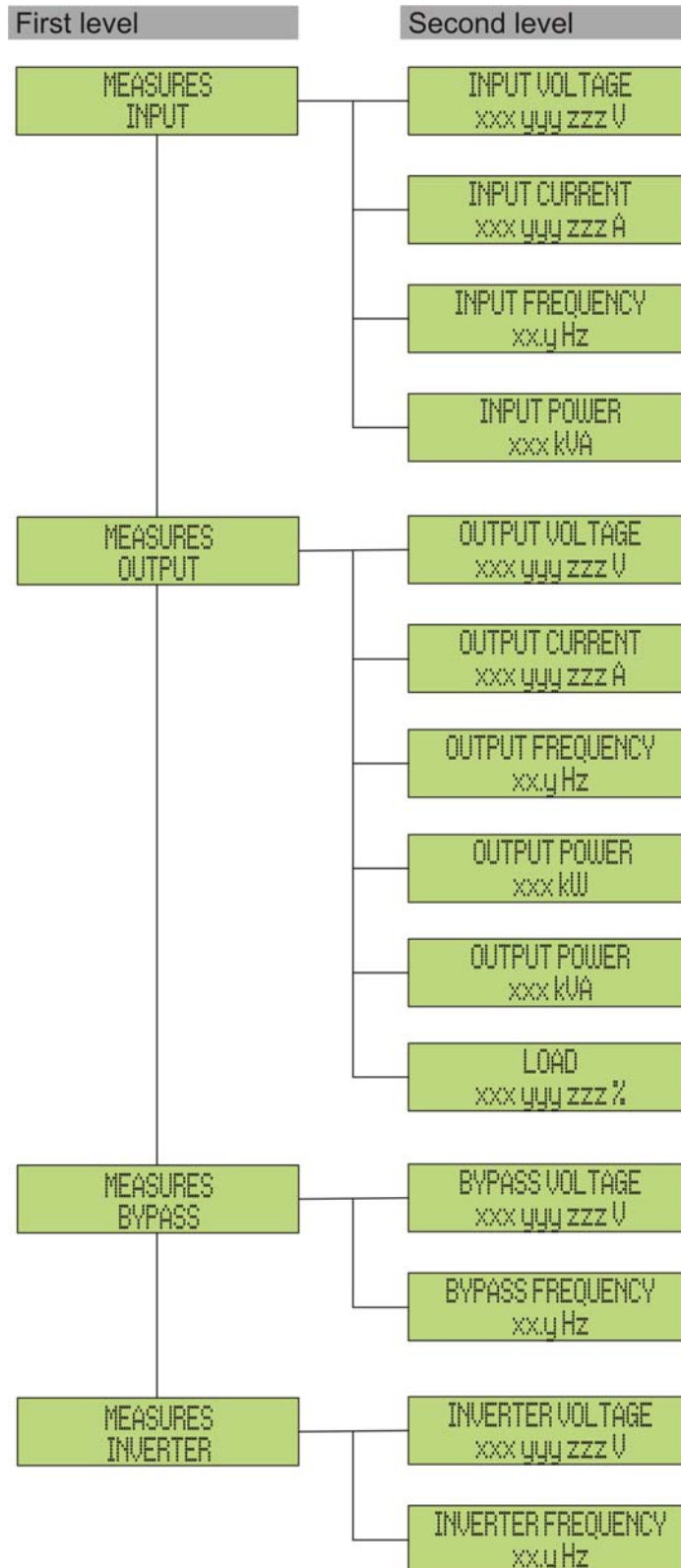

Picture 8 – Structure of MEASURES menu (1 of 2)

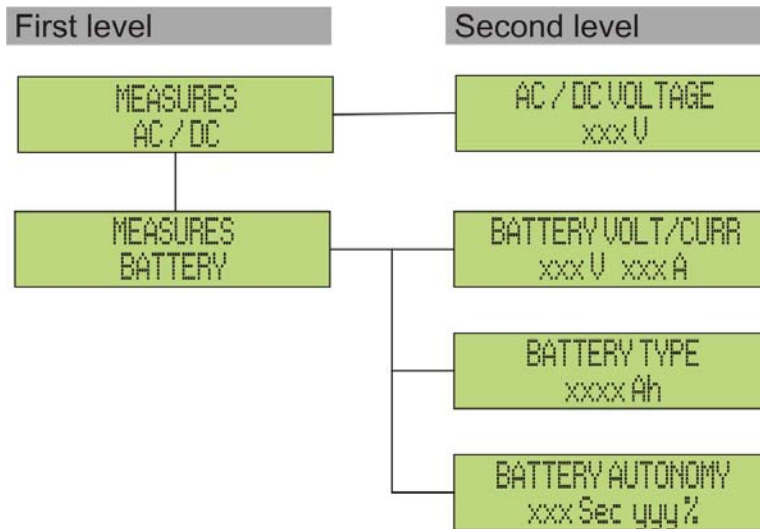

Picture 9 – Structure of MEASURES menu (2 of 2)

Sub-menu	Displayed data	Accuracy
INPUT	Rectifier input voltage ⁽¹⁾ ⁽²⁾	1 V
	Rectifier input current ⁽³⁾	1 A
	Frequency	0.1 Hz
	Input power	1 kVA
OUTPUT	Voltage ⁽¹⁾ ⁽²⁾	1 V
	Current ⁽³⁾	1 A
	Frequency	0.1 Hz
	Active power	1 kW
	Apparent power	1 kVA
	Load percentage	1 %
BYPASS	Voltage ⁽¹⁾ ⁽²⁾	1 V
	Frequency	0.1 Hz
INVERTER	Voltage ⁽¹⁾ ⁽²⁾	1 V
	Frequency	0.1 Hz
AC/DC	Rectifier output voltage	1 V
BATTERY	Voltage and current	1 V / 1 A
	Nominal capacity	1 Ah
	Residual autonomy	1 min / 1 %

⁽¹⁾ The voltage measures are always referred to the phase-to-neutral value

⁽²⁾ The three voltages are displayed in one screen as “xxx yyy zzz V”

⁽³⁾ The three line currents are displayed in one screen as “xxx yyy zzz A”

5.3 BASIC DIAGNOSTICS

The ALARMS menu allows to display the current operating status of the device and to access the event log, based on the following structure.

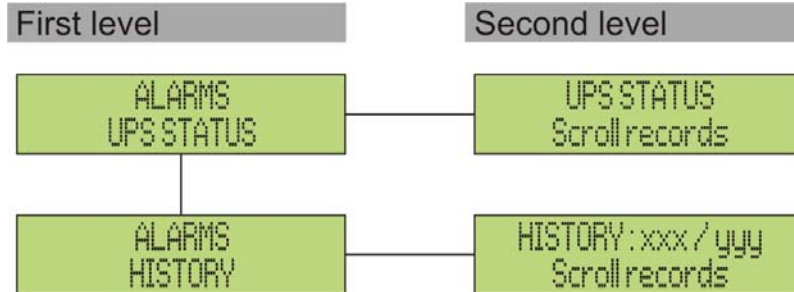

Picture 10 – Structure of ALARMS menu

Sub-menu	Displayed data
UPS STATUS	Alarms present and operating statuses
HISTORY	Event log

The LCD panel displays the ALARMS menu automatically whenever an alarm occurs. The audible indicator, if enabled, is activated to show the occurred failure. The audible alarm is silenced pressing the key  (BUZZER).



Display of the first alarm present (if no alarm is present, the operating status is displayed)



Press the key  to browse the menu and to go to the next alarm/status (in alphabetical order)



Automatic erasure of alarms

Should an alarm occur and then the conditions that originated it no longer exist, the alarm will be automatically cancelled and the system restarted.

5.3.1 Display of alarms history

All the events are recorded in the alarms history.

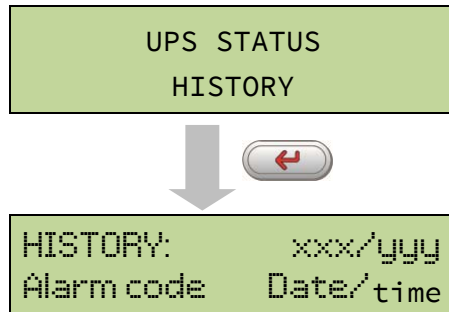

The first event shown is the latest one in order of time; a new event makes all the other events automatically shift one position, clearing the oldest event.

The quantity of stored events is displayed on the first line (xxx/yyy), which contains the data currently displayed (position in the list) and the total number of stored data (maximum number equal to **250**) respectively. An asterisk indicates the automatic reset of the alarm.

```
HISTORY:      001/015
A3 *    26-10-10  20:05
```

Latest event stored (in order of time)

- E.g.: automatic reset of alarm "A3 – BOOSTER STOPPED"

```
HISTORY:      002/015
A3    26-10-10  19:45
```

Immediately prior event

- E.g.: alarm "A3 – BOOSTER STOPPED"

```
HISTORY:      015/015
A18   15-10-10  12:49
```

First event stored (in order of time)

5.3.2 Alarms and operating status

ALARMS

A1	MAINS FAULT	A29	MAINTENANCE REQ
A2	INPUT WRONG SEQ	A30	COMMON ALARM
A3	BOOSTER STOPPED	A31	MBCB BUS CLOSED
A4	BOOSTER FAULT	A32	EPO BUS CLOSED
A5	DC VOLTAGE FAULT	A33	ASYMMETRIC LOAD
A6	BATTERY IN TEST	A34	SERVICE REQUIRED
A7	BCB OPEN	A35	DIESEL MODE
A8	BATTERY DISCHARGE	A36	DC FASTSHUTDOWN
A9	BATTERY AUT END	A37	HIGH TEMP RECT
A10	BATTERY FAULT	A38	INV --> LOAD
A11	SHORT CIRCUIT	A39	INV ERROR LOOP
A12	STOP TIMEOUT SC	A40	SSI FAULT
A13	INV OUT OF TOL	A41	RECT ERROR LOOP
A14	BYPASS WR SEQ	A42	INP FUSES BLOWN
A15	BYPASS FAULT	A43	CURR ERROR LOOP
A16	BYPASS --> LOAD	A44	DESAT IGBT INV
A17	RETRANSFER BLOCK	A45	HIGH TEMP SSW
A18	MBCB CLOSED	A46	PAR LOST REDUND
A19	OCB OPEN	A47	SEND PARAM ERROR
A20	OVERLOAD	A48	RCV PARAM ERROR
A21	THERMAL IMAGE	A49	TEST MODE ERROR
A22	BYPASS SWITCH	A50	SSW BLOCKED
A23	EPO PRESSED	A51	BATT TEMPERATURE
A24	HITMP INV/DC FUS	A53	FIRMWARE ERROR
A25	INVERTER OFF	A54	CAN ERROR
A26	COMMUNIC ERROR	A55	PAR CABLE DISC
A27	EEPROM ERROR	A56	MAINS UNBALANCE
A28	CRITICAL FAULT	A63	START SEQ BLOCK

STATUSES

- S1 BOOSTER OK
- S2 BATTERY OK
- S3 INVERTER OK
- S4 INVERTER --> LOAD
- S5 INV BYPASS SYNC
- S6 BYPASS OK
- S7 BYPASS --> LOAD
- S8 BOOST CHARGE
- S9 INV MASTER SYNC



Display and recording mode of alarms

- The statuses are always displayed in ascending order when the ALARMS – STATUSES menu is entered.
 - The alarms are shown when they are present and must be silenced with the buzzer.
 - The alarms remain displayed whilst they are present and they are automatically stored in the event log with date and time.
-



Description of alarms and statuses

For a more detailed description of the alarms and statuses, see the “Faults and alarms” section of the present manual.

6 SETTINGS AND ADVANCED OPERATIONS

Some operating parameters of the UPS can be set via the SPECIAL menu, which is structured as follows:

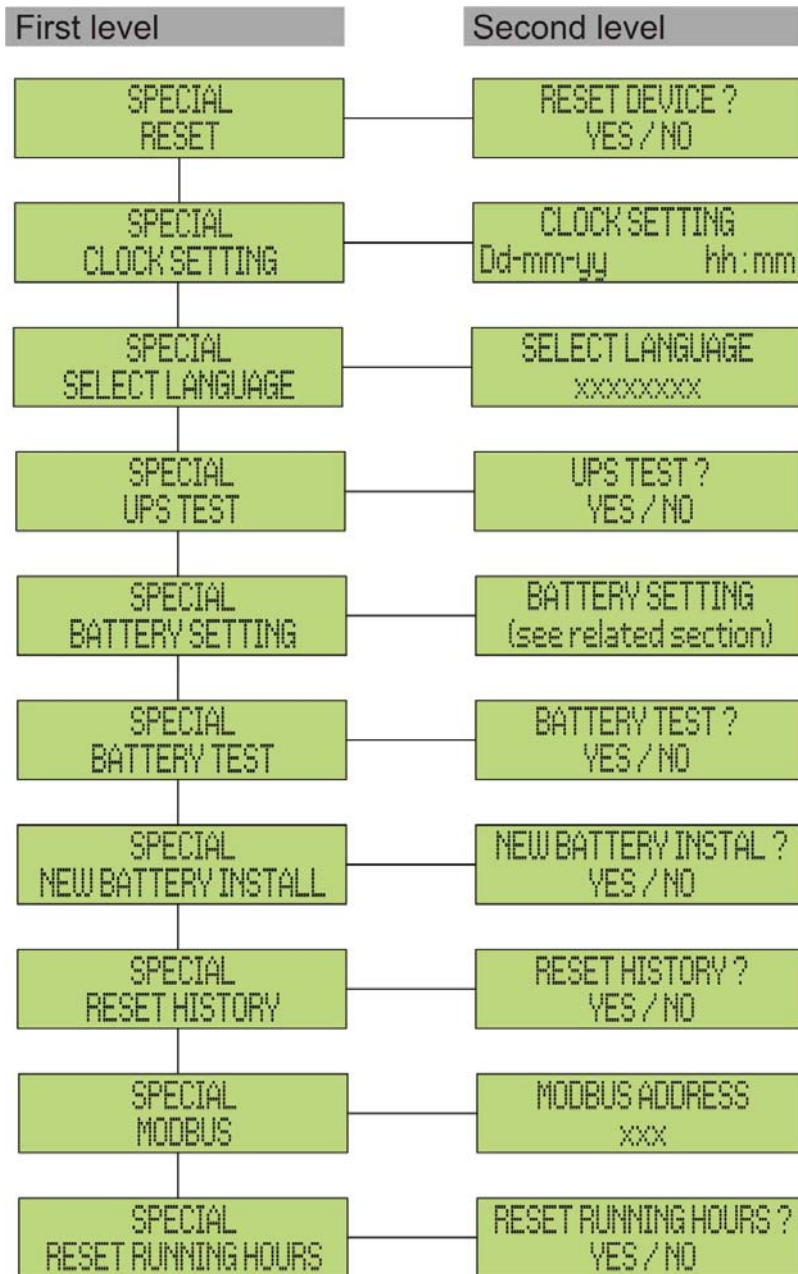

Picture 11 – Structure of SPECIAL menu

Sub-menu	Programmable data
RESET	Reset of failure conditions
CLOCK SETTING	System date and time
SELECT LANGUAGE	Display language setting
UPS TEST	Performs a commutation test
BATTERY SETTING	Battery parameter setting
BATTERY TEST	Performs a battery test
NEW BATTERY INSTALL	Sets autonomy to 100%
RESET HISTORY	Event log reset
MODBUS	MODBUS address of device
RESET RUNNING HOURS	Reset the hour counter related to the UPS running time



Password-protected access

The SETTINGS menu is protected by a password set by the factory in order to prevent access to unauthorized personnel.

- We recommend minimum disclosure of the access password.
- Changes to the operating parameters and starting operations on the UPS may be potentially dangerous for the device and for persons.

6.1 SETTING DATE AND TIME

Date and time may be set via the CLOCK menu.

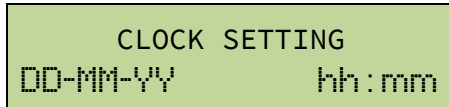

The single digits can be modified via the arrow keys (▲ / ▼) and confirmed by pressing ↵ (ENTER).



Setting the current date and time correctly

The correct setting of the date and time is essential for the recording of the event log.

6.2 DISPLAY LANGUAGE SETTING

The table below shows the languages which can be set for the display.

Parameter	Range
LANGUAGE	ITALIAN GERMAN FRENCH ENGLISH PORTUGUESE SPANISH POLISH TURKISH

The parameters are changed via the arrow buttons (▲ / ▼) to increase the digits, and the ↵ button is used to confirm the entry.

6.3 NEW BATTERY INSTALLATION

The NEW BATTERY INSTALLATION menu is used in case battery circuit breaker BCB is not closed, when requested, in the start-up phase. In this case the system will start considering the battery completely discharged and activating the alarm "A10 – BATTERY FAULT".

To set the battery autonomy to 100% it is necessary to access the menu and press the ↵ button to confirm.

6.4 BATTERY CONFIGURATION

In case the UPS has been tested without knowing the characteristic data of the storage battery, the BATTERY CONFIGURATION menu allows to set such data. In particular, the following data can be set:

- Battery capacity in Ampere-hours (Ah)
- Recharging current in Amperes (A)
- Nominal autonomy in minutes

Access the menu by pressing the button (ENTER).

BAT CAPACITY SETTING
0120

The single digits can be modified via the arrow keys (/) and confirmed by pressing (ENTER).



CONFIRM BATT CAP.?
YES

Confirmation screen of the parameter set



BAT RECHAR CURR SET
18

The single digits can be modified via the arrow keys (/) and confirmed by pressing (ENTER).



CONFIRM RECHAR CURR?
YES

Confirmation screen of the parameter set



AUTONOMY BAT SETTING
0020

The single digits can be modified via the arrow keys (/) and confirmed by pressing (ENTER).



CONFIRM AUTON BATT?
YES

Confirmation screen of the parameter set



SAVE BATT SETTINGS?
YES

Confirmation screen for the configuration



BATT SETTINGS SAVED
PRESS "ENTER"



Setting all the parameters

To save all the parameters it is necessary to reach the end of the guided procedure until the last screen previously shown.

If the procedure is interrupted earlier, none of the parameters previously set will be saved.

6.5 SETTING THE MODBUS PARAMETERS

The parameters regarding the communication via RS485 interface can be set in the MODBUS menu.

➤ Modbus address

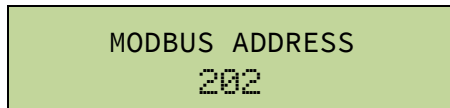

The single digits can be modified via the arrow keys (▲ / ▼) and confirmed by pressing ↵ (ENTER).

Parameter	Standard	Range
MODBUS ADDRESS	1	1 247

6.6 UPS TEST

The UPS TEST menu allows to carry out a switching test of the inverter. The inverter is switched off and the load is transferred to the bypass supply. The inverter supply is automatically restored after a few seconds.

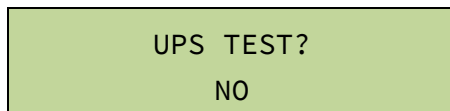

The value on the second line is ready to be changed

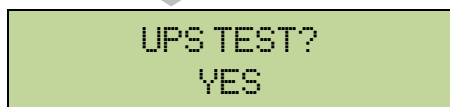

The parameter is changed. The change is confirmed by pressing ↵ (ENTER)



The system performs a test and returns to the previous screen



Possible loss of supply

In case of power failure while the test is being performed, the immediate operation of the inverter is not guaranteed.

6.7 BATTERY TEST

The BATTERY TEST menu allows to carry out a short discharge test of the battery. In case the battery is not efficient, the alarm "A10 – Battery fault" is generated at the end of the test.

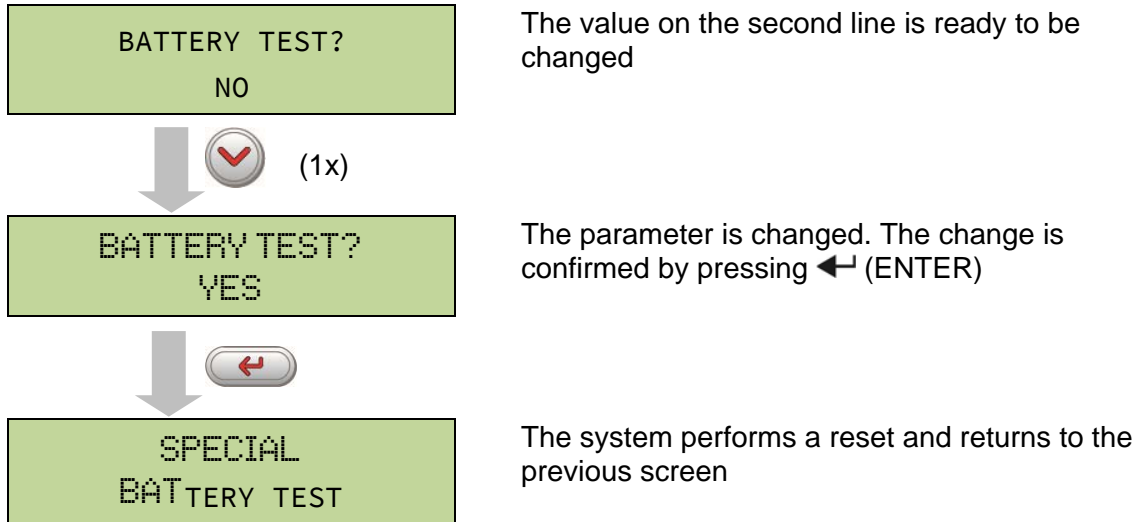

Possible loss of supply

This test can affect the continuity of supply to the loads if the battery is not fully charged.

6.8 SYSTEM RESET

The UPS is equipped with internal protections which block the system or some of its sections. The alarm can be cleared and normal operation can be resumed via the RESET menu. In case the failure persists, the UPS will return to the previous failure condition.

In some cases the RESET is necessary to simply reset a failure signal, then the UPS will resume operation.

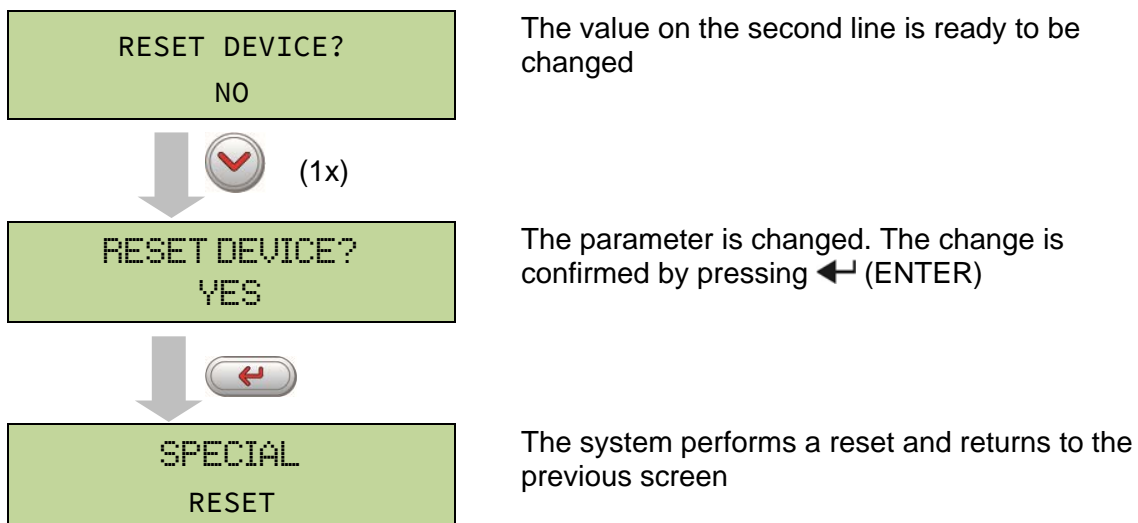

The failure conditions which impose a manual reset are:

- Static switch re-transfer block (alarm A17)
- Inverter shutdown due to the operation of the IGBT desaturation sensor (alarm A44)
- Inverter shutdown due to short-circuit timeout (alarm 12)
- Inverter shutdown due to thermal image protection (alarm 21)
- Inverter shutdown due to the operation of the quick disconnect sensor (alarm A36)
- Inverter shutdown due to voltage control loop error (alarm A39)
- Booster shutdown due to voltage control loop error (alarm A41)
- Booster shutdown due to current control loop error (alarm A43)
- Static switch blocked (alarm A50)
- Booster shutdown due to the operation of the load symmetry sensor (alarm A33)
- Activation of the battery fault alarm (alarm A10)
- Scheduled maintenance request (alarm A29).

For a description of the UPS status in each of the failure conditions listed above, please refer to the "Faults and alarms" section.

6.9 ALARMS HISTORY RESET

Access the RESET HISTORY menu.

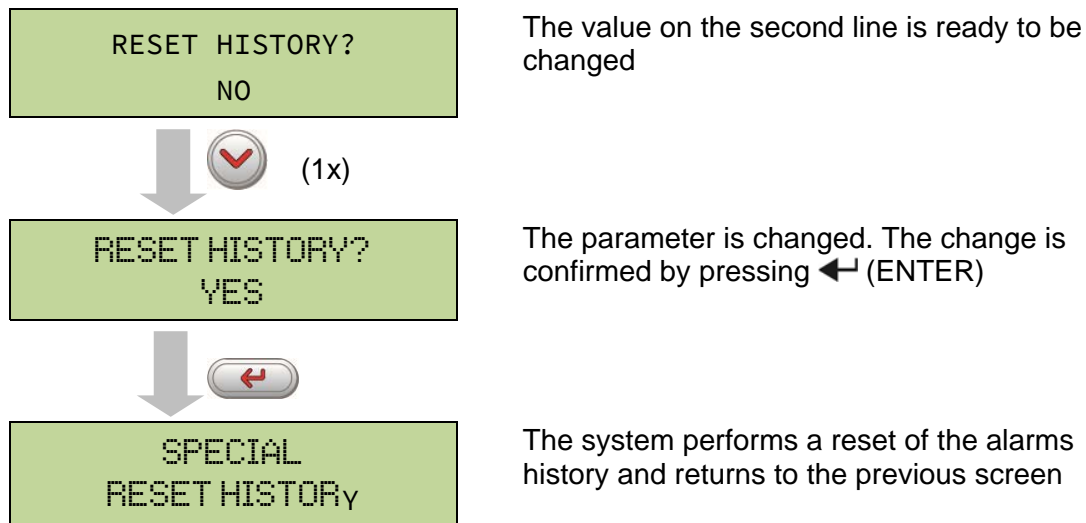

Loss of data

The alarms history contains very important data to monitor the device behaviour over time. We recommend to save the data before deleting it.

7 SYSTEM INFORMATION

The INFO menu provides general information regarding the UPS based on the structure indicated below.

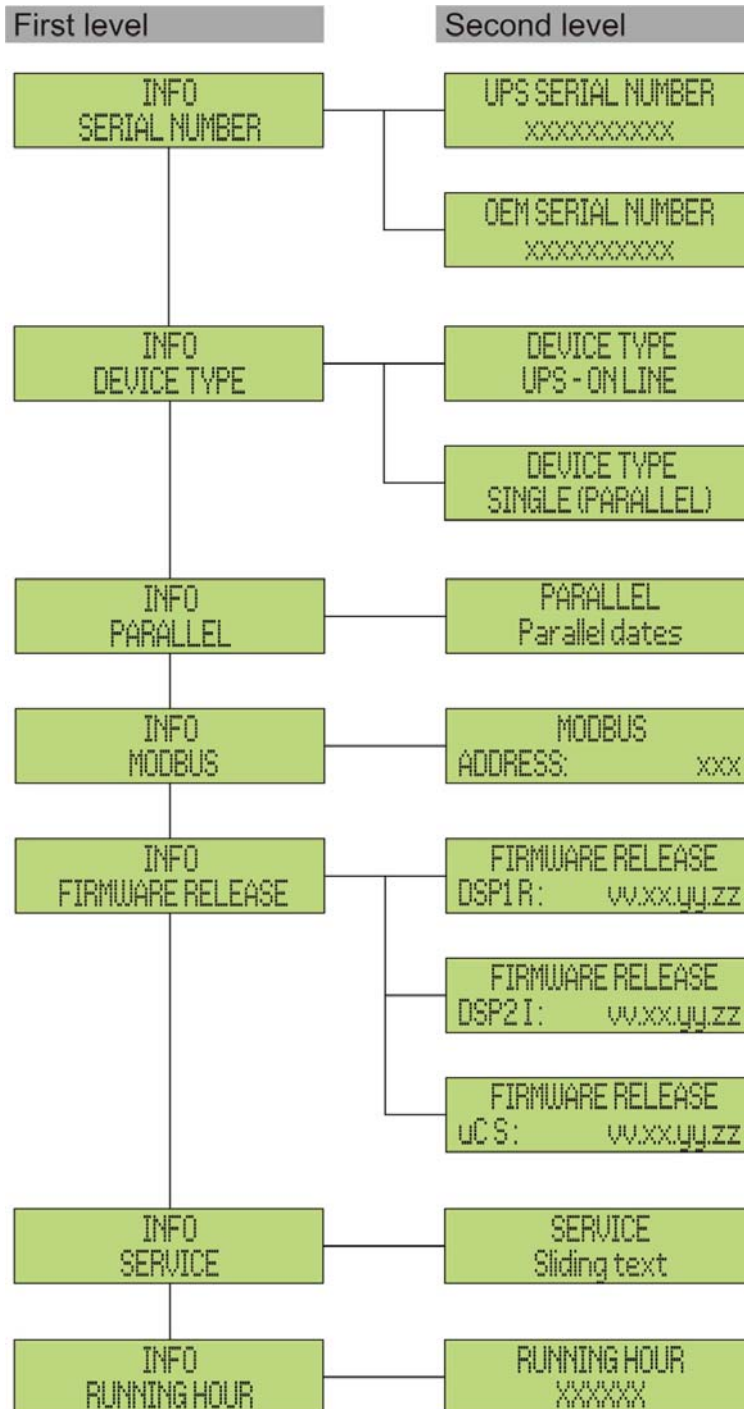

Picture 12 – Structure of INFO menu

All data shown in the various sections are set by the factory via a special interface software and cannot be altered, except by personnel authorized by the manufacturer.

The only adjustable parameters are the MODBUS settings (see SPECIAL menu).

Sub-menu	Displayed data
SERIAL NUMBER	Device serial number given by the manufacturer and by an OEM distributor, if any
DEVICE TYPE	The device type can be: <ul style="list-style-type: none"> ➤ ON LINE - UPS ➤ FREQUENCY CONVERTER ➤ ECO MODE - UPS ➤ SINGLE UPS ➤ PARALLEL
PARALLEL ⁽¹⁾	Data regarding the parallel configuration
MODBUS	MODBUS address of device
FIRMWARE RELEASE	Firmware versions installed on the system
SERVICE	Scrolling text string with information regarding technical service
RUNNING HOUR	Dates related to hours number of UPS running time

⁽¹⁾ the menu is only active if the UPS belongs to a Parallel or Load Sync system

7.1 PARALLEL OPERATION INFORMATION

The PARALLEL menu is only active if the UPS belongs to a parallel or load-sync system.

7.1.1 UPS position

```

    PARALLEL
    2 / 6
    
```

The first number on the second line identifies the *position* of that specific UPS within the parallel system. The second number represents the total number of UPS units.

7.1.2 Master / Slave priority

```

    PARALLEL
    MASTER
    
```

The string on the second line may have two values, "MASTER" or "SLAVE". Only one *MASTER UPS* can be present in the system; if not there will be a conflict on the data communication bus.

7.1.3 Communication bus monitoring

```
PARALLEL
1- [ M  2-  3- S  4- S
   ]      S
```

The second line of this menu gives a general indication regarding the communication between the UPS units composing the system.

- The numbers represent the single UPS units.
- The letters M and S stand for MASTER and SLAVE respectively.
- The brackets [] around a letter indicate that we are working on that specific UPS unit.
- A question mark next to a number indicates that that UPS unit is not communicating on the data bus.

Let us assume to have the following situation:

- system composed of 4 UPS units;
- UPS2 is currently the MASTER UPS;
- we are checking the data communication on UPS3;
- UPS4 is not communicating.

The menu will be as shown below.

```
PARALLEL
1- S  2-  3- [  4- ?
      M  S ]
```

In case there are more than four paralleled devices, the menu will be as follows.

```
PARALLEL
1- S  2-  3- [  ....
      M  S ]
```

The dots indicate the presence of a further menu which shows the status of the other UPS units in the system.

7.1.4 Parallel type

```
PARALLEL
REDUNDANT+x
```

The string on the second line may have two values, "POWER" or "REDUNDANT+x".

- POWER means that the parallel system is so set as to require the presence of all the UPS units to feed the load.

-
- REDUNDANT+x means that the system is redundant and the redundancy index is indicated by number “x”. For example, in a system composed of 3 UPS units, “REDUNDANT+2” means that only one of the UPS units is sufficient to feed the load.

7.1.5 Message statistics

The statistics section regarding the messages exchanged on the communication buses consists of three different menus.

```
STATIST CAN SSW  
MSG RX: 32564  
100.0%
```

Number of messages received and percentage of reception accuracy regarding the status of the static switches. The messages are exchanged between all the UPS units, therefore the number will increase on all of them.

```
STATIST CAN INV  
SYNC RX: 15849  
100.0%
```

Number of messages received and percentage of reception accuracy regarding the synchronism signals. The messages are sent by the MASTER UPS, therefore the number will only increase on the SLAVE UPS units.

```
STATIST CAN INV  
MSG RX: 9277  
99.9%
```

Number of messages received and percentage of reception accuracy regarding the status of the system. The messages are exchanged between all the UPS units, therefore the number will increase on all of them.

7.2 SERVICE INFORMATION

The SERVICE menu provides important information regarding the technical service on the UPS.

The information is displayed via a text string of max. 60 characters which scrolls on the second display line.

However, please also see the addresses and contact numbers indicated in the present manual.

8 FAULTS AND ALARMS

As indicated in the previous chapters, the system is provided with basic diagnostics which allow immediate visualization of the operating conditions.

The LCD panel displays the alarms screen immediately, and an audible indicator is activated (if enabled). Each screen displays the alphanumeric alarm code and a short description of the alarm.

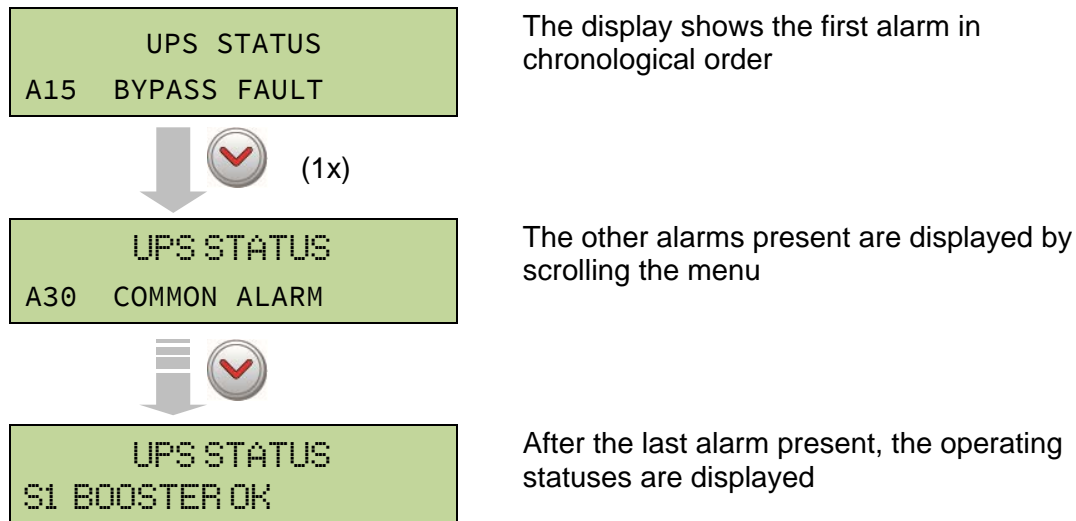

Injury hazard due to electric shock!

Before carrying out any operation on the UPS, make sure that all the safety precautions are adhered to:

- Any work on the unit must be carried out by qualified personnel;
- Internal components can only be accessed after disconnecting the device from supply sources;
- Always use protective devices designed for each type of activity;
- The instructions contained in the manuals must be strictly followed;
- In case of doubt or impossibility of solving the problem, please contact Legrand immediately.

8.1 OPERATING STATUS DEFINITION

Status	S1	BOOSTER OK
Description	The rectifier section is working properly.	
Operating condition	The rectifier supplies the inverter and keeps the battery charged.	

Status	S2	BATTERY OK
Description	The battery is connected to the UPS.	
Operating condition	The battery is kept charged by the rectifier and is ready to feed the inverter.	

Status	S3	INVERTER OK
Description	The inverter voltage and frequency are within the allowed range.	
Operating condition	The inverter is ready to feed the load.	

Status	S4	INVERTER --> LOAD
Description	The inverter feeds the load.	
Operating condition	The load is fed via the static inverter switch.	

Status	S5	INV BYPASS SYNC
Description	The inverter is synchronized with the bypass.	
Operating condition	The synchronization between the inverter and the bypass is locked, and the static switch can change over from one source to the other.	

Status	S6	BYPASS OK
Description	The bypass voltage and frequency are within the allowed range.	
Operating condition	The bypass line is ready for changeover in case of inverter failure.	

Status	S7	BYPASS --> LOAD
Description	Load fed by the bypass line.	
Operating condition	The load is fed by the bypass via the static switch, waiting for the inverter to restart.	

Status	S8	BOOST CHARGE
Description	The battery is in <i>BOOST</i> charge.	
Operating condition	The rectifier is charging the battery with a higher voltage. The return to <i>FLOATING</i> charge mode is automatic.	

Status	S9	INV MASTER SYNC
Description	The inverter is synchronized with the MASTER UPS.	
Operating condition	This status is only present on the SLAVE UPS units, and shows that the inverter is synchronized with the signal sent by the MASTER UPS.	

8.2 TROUBLESHOOTING

Alarm	A1	MAINS FAULT
Description	The voltage or frequency of the input line are out of tolerance.	
Possible causes	<ul style="list-style-type: none"> ➤ Mains instability or failure. ➤ Wrong phase rotation. 	
Solutions	<ol style="list-style-type: none"> 1. Check the connections to the mains. 2. Check the stability of mains voltage. 3. If the alarm persists, contact our Technical Support Service. 	

Alarm	A2	INPUT WRONG SEQ
Description	The phase rotation on the rectifier input line is wrong.	
Possible causes	<ul style="list-style-type: none"> ➤ Wrong connection of power cables. 	
Solutions	<ol style="list-style-type: none"> 1. Check the phase rotation. 2. If the alarm persists, contact our Technical Support Service. 	

Alarm	A3	BOOSTER STOPPED
Description	The rectifier has been temporarily disconnected and the inverter is fed by the battery.	
Possible causes	<ul style="list-style-type: none"> ➤ Instability of the AC line voltage or frequency. ➤ Possible fault in the rectifier control circuit. 	
Solutions	<ol style="list-style-type: none"> 1. Check the parameters of the AC line voltage. 2. Restart the device. 3. If the alarm persists, contact our Technical Support Service. 	

Alarm	A4	BOOSTER FAULT
Description	The rectifier has been disconnected due to an internal fault.	
Possible causes	<ul style="list-style-type: none"> ➤ Possible fault in the rectifier control circuit. 	
Solutions	<ol style="list-style-type: none"> 1. Check which alarms are present and carry out the indicated procedures. 2. Restart the device. 3. If the alarm persists, contact our Technical Support Service. 	

Alarm	A5 DC VOLTAGE FAULT
Description	The measured DC voltage is out of tolerance.
Possible causes	<ul style="list-style-type: none"> ➤ The battery has reached the discharge voltage due to a power failure. ➤ Measuring circuit failure.
Solutions	<ol style="list-style-type: none"> 1. Check the actual value of the measured DC voltage. 2. In case of mains failure, wait for the AC voltage to be restored. 3. Check which alarms are present and carry out the indicated procedures. 4. Restart the device. 5. If the alarm persists, contact our Technical Support Service.

Alarm	A6 BATTERY IN TEST
Description	The rectifier voltage is reduced to start a short controlled discharge of the battery.
Possible causes	<ul style="list-style-type: none"> ➤ A battery test has been started automatically (if set), or manually by the user.
Solutions	<ol style="list-style-type: none"> 1. Wait for the test to end, and check possible battery faults.

Alarm	A7 BCB OPEN
Description	The battery isolator is open.
Possible causes	<ul style="list-style-type: none"> ➤ Battery isolator open.
Solutions	<ol style="list-style-type: none"> 1. Check the status of the battery isolator. 2. Check the functionality of the auxiliary contact of the isolator. 3. Check the connection between the auxiliary contact of the isolator and the auxiliary terminals of the UPS (if provided). 4. If the alarm persists, contact our Technical Support Service.

Alarm	A8 BATTERY DISCHARGE
Description	The battery is discharging.
Possible causes	<ul style="list-style-type: none"> ➤ The battery is discharging due to a mains failure. ➤ Rectifier failure.
Solutions	<ol style="list-style-type: none"> 1. Check which alarms are present and carry out the indicated procedures. 2. If the alarm persists, contact our Technical Support Service.

Alarm	A9 BATTERY AUT END
Description	The battery has reached the pre-alarm discharge level.
Possible causes	<ul style="list-style-type: none"> ➤ The battery is discharging due to a mains failure. ➤ Rectifier failure.
Solutions	<ol style="list-style-type: none"> 1. Check which alarms are present and carry out the indicated procedures. 2. If the alarm persists, contact our Technical Support Service.

Alarm	A10 BATTERY FAULT
Description	Fault following a battery test.
Possible causes	<ul style="list-style-type: none"> ➤ Battery fault.
Solutions	<ol style="list-style-type: none"> 1. Check the battery. 2. Reset the system. 3. If the alarm persists, contact our Technical Support Service.

Alarm	A11 SHORT CIRCUIT
Description	The current sensor has detected a short-circuit at the output.
Possible causes	<ul style="list-style-type: none"> ➤ Load problem. ➤ Measuring circuit failure.
Solutions	<ol style="list-style-type: none"> 1. Check the loads connected to the UPS output. 2. If the alarm persists, contact our Technical Support Service.

Alarm	A12 STOP TIMEOUT SC
Description	Inverter shutdown due to an extended short-circuit during a power failure, or due to an overcurrent on the inverter bridge input.
Possible causes	<ul style="list-style-type: none"> ➤ Short-circuit on the loads during a power failure. ➤ Inverter bridge fault. ➤ Temporary current peak.
Solutions	<ol style="list-style-type: none"> 1. Reset the system. 2. If the alarm persists, contact our Technical Support Service.

Alarm	A13 INV OUT OF TOL
Description	The inverter voltage or frequency are out of tolerance.
Possible causes	<ul style="list-style-type: none"> ➤ Inverter shutdown due to an alarm. ➤ Inverter failure.
Solutions	<ol style="list-style-type: none"> 1. Check which alarms are present and carry out the indicated procedures. 2. If the alarm persists, contact our Technical Support Service.

Alarm	A14 BYPASS WR SEQ
Description	The phase rotation of the bypass line is wrong.
Possible causes	<ul style="list-style-type: none"> ➤ Wrong connection of power cables.
Solutions	<ol style="list-style-type: none"> 1. Check the phase rotation. 2. If the alarm persists, contact our Technical Support Service.

Alarm	A15 BYPASS FAULT
Description	The voltage or frequency of the bypass line are out of tolerance.
Possible causes	<ul style="list-style-type: none"> ➤ Bypass line instability or failure. ➤ Wrong phase rotation.
Solutions	<ol style="list-style-type: none"> 1. Check the connections to the mains. 2. Check the stability of mains voltage. 3. If the alarm persists, contact our Technical Support Service.

Alarm	A16 BYPASS --> LOAD
Description	The load is fed by the bypass line.
Possible causes	<ul style="list-style-type: none"> ➤ Temporary changeover due to inverter failure.
Solutions	<ol style="list-style-type: none"> 1. Verify the inverter status and check whether other alarms are present. 2. If the alarm persists, contact our Technical Support Service.

Alarm	A17 RETRANSFER BLOCK
Description	The load is blocked on the bypass line.
Possible causes	<ul style="list-style-type: none"> ➤ Very frequent changeovers due to load in-rush currents. ➤ Static switch problems.
Solutions	<ol style="list-style-type: none"> 1. Reset the system. 2. Check the in-rush currents of the loads. 3. If the alarm persists, contact our Technical Support Service.

Alarm	A18 MBCB CLOSED
Description	The manual bypass isolator is closed.
Possible causes	<ul style="list-style-type: none"> ➤ Manual bypass isolator closed.
Solutions	<ol style="list-style-type: none"> 1. Check the status of the manual bypass isolator. 2. Check the functionality of the auxiliary contact of the isolator. 3. If the alarm persists, contact our Technical Support Service.

Alarm	A19 OCB OPEN
Description	The output isolator is open.
Possible causes	<ul style="list-style-type: none"> ➤ Output isolator open.
Solutions	<ol style="list-style-type: none"> 1. Check the status of the output isolator. 2. Check the functionality of the auxiliary contact of the isolator. 3. If the alarm persists, contact our Technical Support Service.

Alarm	A20 OVERLOAD
Description	The current sensor has detected an overload at the output. If the alarm persists, the thermal image protection will be activated (alarm A21).
Possible causes	<ul style="list-style-type: none"> ➤ Output overload. ➤ Measuring circuit failure.
Solutions	<ol style="list-style-type: none"> 1. Check the loads connected to the UPS output. 2. Contact our Technical Support Service.

Alarm	A21 THERMAL IMAGE
Description	The thermal image protection has been activated after an extended inverter overload. The inverter is shut down for 30 minutes and then restarted.
Possible causes	<ul style="list-style-type: none"> ➤ Output overload. ➤ Measuring circuit failure.
Solutions	<ol style="list-style-type: none"> 1. Check the loads connected to the UPS output. 2. Should you need to restore the inverter supply immediately, reset the system. 3. If the alarm persists, contact our Technical Support Service.

Alarm	A22 BYPASS SWITCH
Description	The "Normal/Bypass" selector has been operated.
Possible causes	<ul style="list-style-type: none"> ➤ Maintenance operation.
Solutions	<ol style="list-style-type: none"> 1. Check the selector position. 2. If the alarm persists, contact our Technical Support Service.

Alarm	A23 EPO PRESSED
Description	The system is blocked due to the activation of the emergency power off button.
Possible causes	<ul style="list-style-type: none"> ➤ Activation of the (local or remote) emergency power off button.
Solutions	<ol style="list-style-type: none"> 1. Release the emergency power off button and reset the alarm. 2. If the alarm persists, contact our Technical Support Service.

Alarm	A24 HITMP INV/DC FUS
Description	High temperature of the heat sink on the inverter bridge or tripping of the DC fuses which protect the inverter bridge.
Possible causes	<ul style="list-style-type: none"> ➤ Fault of the heat sink cooling fans. ➤ The room temperature or cooling air temperature is too high. ➤ Tripping of the DC protection fuses.
Solutions	<ol style="list-style-type: none"> 1. Check the fans operation. 2. Clean the ventilation grids and the air filters, if any. 3. Check the air conditioning system (if present). 4. Check the status of the DC fuses on the inverter bridge input. 5. If the alarm persists, contact our Technical Support Service.

Alarm	A25 INVERTER OFF
Description	The inverter is blocked due an operation failure.
Possible causes	➤ Various.
Solutions	<ol style="list-style-type: none"> 1. Reset the system. 2. If the alarm persists, contact our Technical Support Service.

Alarm	A26 COMMUNIC ERROR
Description	Internal error.
Possible causes	➤ Microcontroller communication problems.
Solutions	<ol style="list-style-type: none"> 1. If the alarm persists, contact our Technical Support Service.

Alarm	A27 EEPROM ERROR
Description	The controller has detected an error in the parameters stored in E ² PROM.
Possible causes	➤ Wrong parameters entered during programming.
Solutions	<ol style="list-style-type: none"> 1. Contact our Technical Support Service.

Alarm	A28 CRITICAL FAULT
Description	An alarm has been activated which causes the shutdown of part of the UPS (rectifier, inverter, static switch).
Possible causes	➤ System failure.
Solutions	<ol style="list-style-type: none"> 1. Check which alarms are present and carry out the indicated procedures. 2. If the alarm persists, contact our Technical Support Service.

Alarm	A29 MAINTENANCE REQ
Description	It is necessary to carry out maintenance work.
Possible causes	➤ The time limit since the last maintenance work has elapsed.
Solutions	<ol style="list-style-type: none"> 1. Contact our Technical Support Service.

Alarm	A30	COMMON ALARM
Description	Common alarm.	
Possible causes	➤ At least one alarm is present.	
Solutions	1. Check which alarms are present and carry out the indicated procedures.	

Alarm	A31	MBCB BUS CLOSED
Description	The manual bypass isolator is closed.	
Possible causes	➤ Manual bypass isolator closed.	
Solutions	1. Check the status of the manual bypass isolator. 2. Check the functionality of the auxiliary contact of the isolator. 3. If the alarm persists, contact our Technical Support Service.	

Alarm	A32	EPO BUS CLOSED
Description	The system is blocked due to the activation of the emergency power off button.	
Possible causes	➤ Activation of the (local or remote) emergency power off button.	
Solutions	1. Release the emergency power off button and reset the alarm. 2. If the alarm persists, contact our Technical Support Service.	

Alarm	A33	ASYMMETRIC LOAD
Description	The positive and negative voltages measured on the DC capacitors towards the middle point are different.	
Possible causes	➤ Possible failure on the measuring circuit. ➤ Possible fault of DC capacitors.	
Solutions	1. Reset the system. 2. If the alarm persists, contact our Technical Support Service.	

Alarm	A34	SERVICE REQUIRED
Description	A UPS check is necessary.	
Possible causes	➤ Possible UPS fault.	
Solutions	1. If the alarm persists, contact our Technical Support Service.	

Alarm	A35 DIESEL MODE
Description	The UPS is supplied by the diesel generator.
Possible causes	<ul style="list-style-type: none"> ➤ The auxiliary contact which activates the diesel generator connected to the UPS is closed, and imposes this operating mode.
Solutions	<ol style="list-style-type: none"> 1. Wait for the diesel generator to stop as soon as the mains voltage is restored. 2. Check the connection of the auxiliary contact which signals the diesel generator start, to terminals XD1/XD2. 3. If the alarm persists, contact our Technical Support Service.

Alarm	A36 DC FASTSHUTDOWN
Description	Inverter shutdown due to the operation of the protection sensor as a result of sudden DC voltage variations.
Possible causes	<ul style="list-style-type: none"> ➤ Battery fault.
Solutions	<ol style="list-style-type: none"> 1. Check the battery. 2. Reset the system. 3. If the alarm persists, contact our Technical Support Service.

Alarm	A37 HIGH TEMP RECT
Description	High temperature of the rectifier heat sink.
Possible causes	<ul style="list-style-type: none"> ➤ Fault of the heat sink cooling fans. ➤ The room temperature or cooling air temperature is too high.
Solutions	<ol style="list-style-type: none"> 1. Check the fans operation. 2. Clean the ventilation grids and the air filters, if any. 3. Check the air conditioning system (if present). 4. If the alarm persists, contact our Technical Support Service.

Alarm	A38 INV --> LOAD
Description	The load is fed by the inverter. This alarm is active for UPS systems in "ECO" mode, where the preferential supply is from the bypass line.
Possible causes	<ul style="list-style-type: none"> ➤ Temporary changeover due to bypass line failure.
Solutions	<ol style="list-style-type: none"> 1. Verify the status of the bypass line and check whether other alarms are present. 2. If the alarm persists, contact our Technical Support Service.

Alarm	A39 INV ERROR LOOP
Description	The control is not able to regulate the inverter voltage precisely.
Possible causes	➤ Regulation system failure.
Solutions	<ol style="list-style-type: none"> 1. Reset the system. 2. If the alarm persists, contact our Technical Support Service.

Alarm	A40 SSI FAULT
Description	The system has detected a failure in the static inverter switch.
Possible causes	<ul style="list-style-type: none"> ➤ Possible problems on the loads. ➤ Static switch fault.
Solutions	<ol style="list-style-type: none"> 1. Check the absorption of the loads and the presence of DC components, if any, on AC current. 2. If the alarm persists, contact our Technical Support Service.

Alarm	A41 RECT ERROR LOOP
Description	The control is not able to regulate the rectifier output voltage precisely.
Possible causes	➤ Regulation system failure.
Solutions	<ol style="list-style-type: none"> 1. Reset the system. 2. If the alarm persists, contact our Technical Support Service.

Alarm	A42 INP FUSES BLOWN
Description	Failure of the AC protection fuses on rectifier input.
Possible causes	➤ Input overcurrent.
Solutions	<ol style="list-style-type: none"> 1. Check the fuses verifying the status of the blowing indicator. 2. Replace the blown fuses, if any. 3. Restart the system. 4. If the alarm persists, contact our Technical Support Service.

Alarm	A43 CURR ERROR LOOP
Description	The control is not able to regulate the rectifier output current precisely.
Possible causes	➤ Regulation system failure.
Solutions	<ol style="list-style-type: none"> 1. Reset the system. 2. If the alarm persists, contact our Technical Support Service.

Alarm	A44 DESAT IGBT INV
Description	The inverter is blocked due to the operation of the desaturation sensor of the IGBT drivers.
Possible causes	➤ Inverter bridge fault.
Solutions	<ol style="list-style-type: none"> 1. Reset the system. 2. If the alarm persists, contact our Technical Support Service.

Alarm	A45 HIGH TEMP SSW
Description	High temperature of the static switch heat sink.
Possible causes	<ul style="list-style-type: none"> ➤ Fault of the heat sink cooling fans. ➤ The room temperature or cooling air temperature is too high.
Solutions	<ol style="list-style-type: none"> 1. Check the fans operation. 2. Clean the ventilation grids and the air filters, if any. 3. Check the air conditioning system (if present). 4. If the alarm persists, contact our Technical Support Service.

Alarm	A46 PAR LOST REDUND
Description	This alarm is only active on PARALLEL systems. Continuity is not ensured in the event of a fault on one of the UPS units.
Possible causes	<ul style="list-style-type: none"> ➤ The total load is higher than the maximum expected value. ➤ Possible failure on the measuring circuit.
Solutions	<ol style="list-style-type: none"> 1. Check the load fed by the system. 2. If the alarm persists, contact our Technical Support Service.

Alarm	A47 SEND PARAM ERROR
Description	Internal error(WRONG TRANSMISSION OF EEPROM PARAMETERS).
Possible causes	➤ Microcontroller communication problems.
Solutions	1. Contact our Technical Support Service.

Alarm	A48 RCV PARAM ERROR
Description	Internal error(FAILED RECEPTION OF EEPROM PARAMETERS).
Possible causes	➤ Microcontroller communication problems.
Solutions	1. Contact our Technical Support Service.

Alarm	A49 TEST MODE ERROR
Description	Internal error.
Possible causes	➤ Microcontroller communication problems.
Solutions	1. Contact our Technical Support Service.

Alarm	A50 SSW BLOCKED
Description	The static switch is blocked. The load is no longer supplied.
Possible causes	➤ Loads failure. ➤ Possible UPS fault.
Solutions	1. Check the loads for possible failures. 2. Reset the system. 3. If the alarm persists, contact our Technical Support Service.

Alarm	A51 BATT TEMPERATURE
Description	The battery temperature is out of tolerance. This alarm is only active when the temperature probe is installed and enabled on the battery.
Possible causes	➤ Anomalous temperature in the battery cabinet. ➤ Possible failure on the measuring circuit.
Solutions	1. Check the temperature on the batteries and remove the cause of the alarm, if any. 2. If the alarm persists, contact our Technical Support Service.

Alarm	A53 FIRMWARE ERROR
Description	The controller has detected an incompatibility in the control software.
Possible causes	➤ The software update was not performed properly.
Solutions	1. Contact our Technical Support Service.

Alarm	A54 CAN ERROR
Description	Internal error.
Possible causes	➤ Microcontroller communication problems.
Solutions	1. Contact our Technical Support Service.

Alarm	A55 PAR CABLE DISC
Description	Parallel cable doesn't communicate.
Possible causes	➤ Parallel cable disconnected or damaged.
Solutions	1. Check the connection of cable 2. Contact our Technical Support Service.

Alarm	A56 MAINS UNBALANCE
Description	The rectifier input voltage is unbalanced.
Possible causes	➤ Problems on the LV or MV distribution network ➤ Defect of the measuring circuit
Solutions	1. Check the input voltage 2. Contact our Technical Support Service.

Alarm	A63 START SEQ BLOCK
Description	During the UPS start-up a failure prevented the proper execution of the sequence.
Possible causes	➤ Control devices in wrong position or operated improperly. ➤ Possible internal fault.
Solutions	1. Make sure the position of the control devices (isolators, selectors) is as specified in the procedures (see "Installation and start-up" section). 2. If the alarm persists, contact our Technical Support Service.

FRANÇAIS

1 PORTEE

Les instructions contenues dans cette section du manuel s'appliquent aux systèmes UPS indiqués ci-dessous.

- KEOR HP 60 kVA
- KEOR HP 80 kVA
- KEOR HP 100 kVA
- KEOR HP 125 kVA
- KEOR HP 160 kVA
- KEOR HP 200 kVA
- KEOR HP 250 kVA
- KEOR HP 300 kVA
- KEOR HP 400 kVA
- KEOR HP 500 kVA
- KEOR HP 600 kVA
- KEOR HP 800 kVA



Stockage de la documentation

Ce manuel ainsi que les autres documentations techniques relatives à ce produit doivent être stockés et mis à disposition du personnel à proximité immédiate de l'UPS.



Autres informations

Si les informations fournies dans le présent manuel ne sont pas suffisamment complètes, veuillez contacter le fabricant de l'appareil, dont les coordonnées sont indiquées dans la section Contacts.

2 RÈGLES DE SECURITE ET AVERTISSEMENTS



Risques de blessure liés à un choc électrique !

Respectez toujours toutes les instructions de sécurité, et plus particulièrement les points suivants :

- toute intervention sur l'unité doit être réalisée par un personnel qualifié ;
- les composants internes ne peuvent être manipulés qu'après déconnexion de l'appareil de ses sources d'alimentation ;
- utilisez toujours des dispositifs de protection conçus pour chaque type d'activité ;
- les instructions contenues dans les manuels doivent être scrupuleusement respectées.



Risques de blessure liés à une défaillance de l'appareil

Des situations potentiellement dangereuses peuvent découler d'une défaillance de l'UPS.

- N'utilisez pas l'appareil s'il est visiblement endommagé.
- Entretenez régulièrement l'appareil afin d'identifier les éventuelles défaillances.



Domages possibles à l'appareil

Lorsqu'une intervention est réalisée sur l'appareil, assurez-vous que toutes les mesures nécessaires sont prises afin d'éviter des décharges électrostatiques susceptibles d'endommager les composants électroniques du système.



Lisez la documentation technique

Avant d'installer et d'utiliser l'appareil, assurez-vous d'avoir lu et compris toutes les instructions contenues dans le présent manuel et la documentation de support technique.

3 DESCRIPTION GÉNÉRALE DE L'UPS

L'UPS utilise la technologie IGBT à haute fréquence d'inversion afin de permettre une faible distorsion du courant réinjecté dans la ligne d'alimentation, ainsi qu'une qualité et une stabilité élevées de la tension en sortie. Les composants utilisés assurent une haute fiabilité, une très haute efficacité et une facilité de maintenance.

3.1 TYPOLOGIE

Les UPS sont des systèmes en ligne à double conversion. L'onduleur inclus dans l'UPS alimente toujours la charge, que le secteur soit ou non disponible (en fonction de l'autonomie de la batterie).

Cette configuration assure à l'utilisateur le meilleur service possible, en offrant une alimentation propre sans interruption, avec stabilisation de la tension et de la fréquence aux valeurs nominales. Grâce à la double conversion, la charge est complètement immunisée contre les micro-coupures et les variations excessives du secteur, tandis que les charges critiques (ordinateurs, instrumentation, équipements scientifiques, etc.) sont protégées contre tout dommage.



Tension de sortie présente

La ligne raccordée à la sortie de l'UPS est alimentée même en cas de panne du secteur. Par conséquent, conformément aux dispositions de la norme CEI EN62040-1-2, l'installateur devra identifier la ligne ou les prises alimentées par l'UPS et les signaler à l'utilisateur.

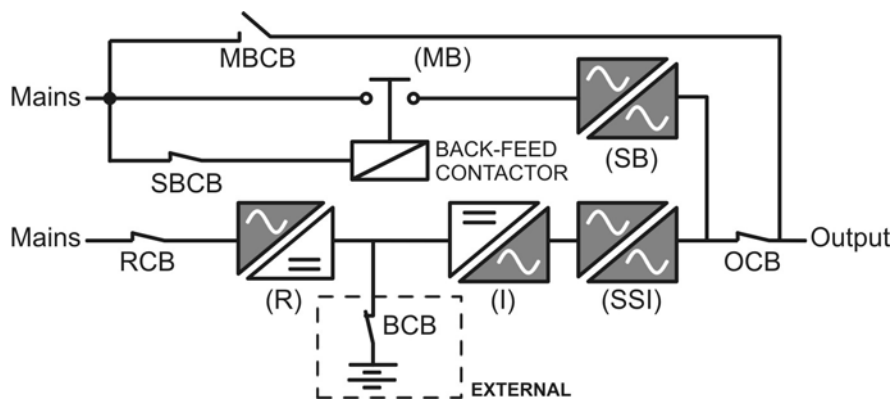

Illustration 1 – Schéma de bloc

3.2 DESCRIPTION DU SYSTÈME

3.2.1 Redresseur

Il convertit la tension triphasée du secteur CA en tension CC.

Il utilise un pont IGBT triphasé entièrement contrôlé avec faible absorption d'harmoniques.

L'électronique de contrôle utilise un microprocesseur 32 bits de dernière génération, qui permet de réduire la distorsion du courant absorbé par le secteur (THDi) à moins de 5 %. Cela garantit que le redresseur ne procède à aucune distorsion de l'alimentation secteur par rapport aux autres charges, tout en évitant la surchauffe des câbles du fait de la circulation des harmoniques.

Le redresseur est dimensionné de façon à alimenter l'onduleur à pleine charge et la batterie au courant de charge maximum.

3.2.2 Onduleur

Il convertit la tension CC issue du redresseur ou de la batterie CC en tension CA stabilisée en amplitude et en fréquence.

L'onduleur utilise la technologie IGBT avec une fréquence d'inversion élevée d'environ 15 kHz.

L'électronique de contrôle utilise un microprocesseur 32 bits de dernière génération qui permet, grâce à ses capacités de traitement, de générer une excellente onde sinusoïdale de sortie.

Par ailleurs, le contrôle entièrement numérique de l'onde sinusoïdale de sortie permet des performances élevées, dont une très faible distorsion de la tension, y compris en présence de charges à haute distorsion.

3.2.3 Batterie et chargeur de batterie

La batterie est installée à l'extérieur de l'UPS. Elle est généralement placée dans une armoire de batterie externe.

La logique du chargeur de batterie est complètement intégrée à l'électronique de contrôle du redresseur.

La batterie est chargée, conformément à la norme DIN 41773, chaque fois qu'elle a été partiellement ou complètement déchargée. Lorsque sa pleine capacité est restaurée, elle est maintenue en charge flottante afin de compenser l'autodécharge.

3.2.4 By-pass statique

Le by-pass statique permet de transférer la charge entre l'onduleur et le secteur d'urgence, et inversement, dans un très court délai. Il utilise des SCR comme éléments de commutation de puissance.

3.2.5 By-pass manuel

Le by-pass manuel est utilisé pour sectionner complètement l'UPS. La charge est alors alimentée directement depuis le secteur d'entrée en cas de maintenance ou de panne importante.



Suivez les procédures indiquées dans le manuel

La séquence de basculement en by-pass manuel et de retour doit être effectuée en suivant la procédure indiquée dans la section relative à l'installation et au démarrage. Le fabricant ne pourra être tenu responsable des dommages liés à une utilisation incorrecte.



By-pass manuel externe

Dans les systèmes UPS de la gamme KEOR HP 400-800 kVA, le sectionneur d'isolation de by-pass manuel est optionnel et se trouve en dehors de l'unité.

3.3 ÉTAT DE FONCTIONNEMENT

L'UPS dispose de quatre modes de fonctionnement différents, décrits ci-dessous :

- Fonctionnement normal
- Fonctionnement en by-pass
- Fonctionnement sur batterie
- By-pass manuel

3.3.1 Fonctionnement normal

Lors d'un fonctionnement normal, tous les disjoncteurs/sectionneurs d'isolation sont fermés, à l'exception du MCB (by-pass de maintenance).

Le redresseur est alimenté par la tension CA triphasée en entrée qui, à son tour, alimente l'onduleur et compense les variations du secteur et de la charge, assurant une tension CC constante. Dans le même temps, il maintient la batterie chargée (chargement flottant ou boost en fonction du type de batterie). L'onduleur convertit la tension CC en onde sinusoïdale CA avec tension et fréquence stabilisées, tout en alimentant la charge via son commutateur statique SSI.

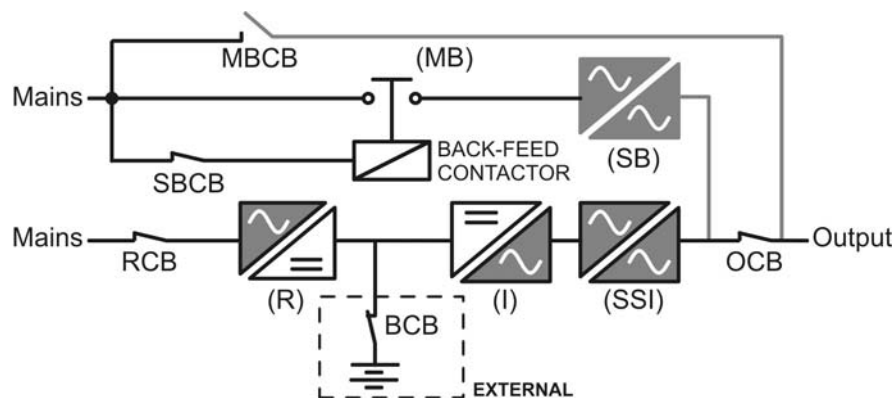

Illustration 2 – Fonctionnement normal

3.3.2 Fonctionnement en by-pass

La charge peut être basculée en by-pass de manière automatique ou manuelle. Le basculement manuel est opéré par le COMMUTATEUR DE BY-PASS qui force la charge sur le by-pass. En cas de défaillance de la ligne de by-pass, la charge est rebasculée vers l'onduleur sans interruption.

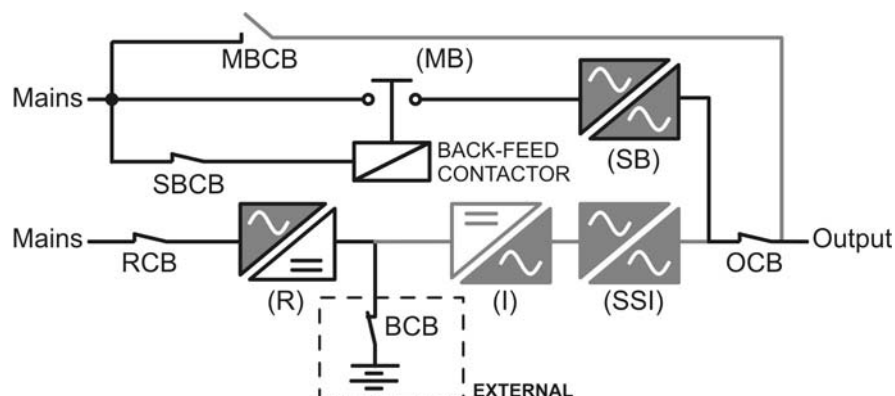

Illustration 3 – Charge alimentée par by-pass

3.3.3 Fonctionnement sur batterie

En cas de défaillance de l'alimentation ou du redresseur, la batterie alimente l'onduleur sans interruption. La tension de la batterie chute en fonction de l'amplitude du courant de décharge. Cette chute de tension n'a pas d'effet sur la tension en sortie, maintenue constante grâce à une modification de la modulation PWM. Une alarme est activée lorsque la batterie approche de sa valeur de décharge minimum.

Si l'alimentation est restaurée avant la décharge complète de la batterie, le système revient automatiquement au fonctionnement normal. Dans le cas contraire, l'onduleur s'arrête et la charge est basculée sur la ligne de by-pass (fonctionnement en by-pass). Si la ligne de by-pass n'est pas disponible ou qu'elle se trouve en dehors des limites de tolérance, l'alimentation de la charge est interrompue dès que la batterie atteint son seuil de décharge limite (*panne totale*).

Dès que l'alimentation est restaurée, le redresseur recharge la batterie. Dans la configuration standard, les charges sont réalimentées via le commutateur statique SSB lorsque le secteur est à nouveau opérationnel. L'onduleur est redémarré une fois que la capacité de la batterie a été partiellement restaurée.

Les conditions de redémarrage du système après une *panne totale* peuvent être personnalisées en fonction des exigences du site, dans trois modes différents :

- Bypass (By-pass) → les charges sont alimentées dès que la ligne de by-pass est disponible (configuration d'usine).
- Inverter (Onduleur) → les charges sont alimentées par l'onduleur (même si la ligne de by-pass est disponible) lorsque la tension de la batterie a atteint un seuil programmé, après redémarrage du redresseur.
- Man. Inverter (Onduleur manuel) → l'alimentation en sortie n'est PAS restaurée automatiquement. Le système nécessite une confirmation de redémarrage qui ne peut être donnée que manuellement par l'utilisateur via le panneau avant.

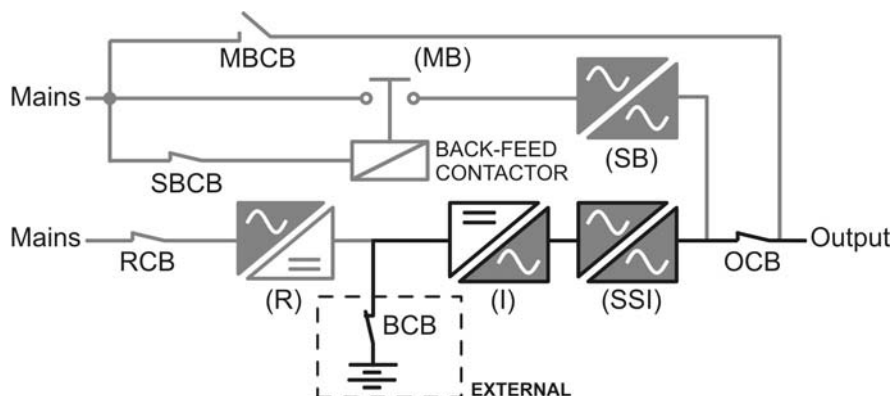

Illustration 4 – Fonctionnement sur batterie

3.3.4 By-pass manuel

Le fonctionnement en by-pass manuel est nécessaire pour tester la fonctionnalité de l'UPS ou lors des interventions de maintenance ou de réparation.

En cas de by-pass manuel pour une intervention de réparation ou de maintenance, l'UPS est complètement arrêté et la charge est alimentée directement par la ligne de by-pass.



Suivez les procédures indiquées dans le manuel

La séquence de basculement en by-pass manuel et de retour doit être effectuée en suivant la procédure indiquée dans la section relative à l'installation et au démarrage. Le fabricant ne pourra être tenu responsable des dommages liés à une utilisation incorrecte.



By-pass manuel externe

Dans les systèmes UPS de la gamme KEOR HP 400-800 kVA, le sectionneur d'isolation de by-pass manuel est optionnel et se trouve en dehors de l'unité.

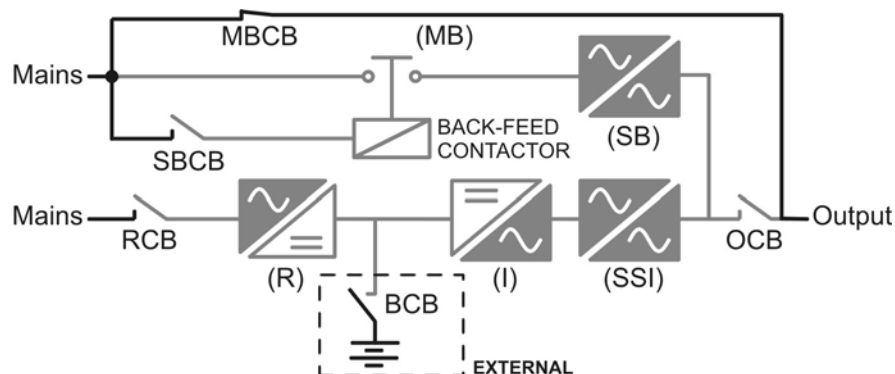

Illustration 5 – By-pass manuel

3.4 DISPOSITIFS DE CONTROLE ET DE FONCTIONNEMENT

Les dispositifs de contrôle et de fonctionnement de l'UPS sont indiqués ci-dessous :

- Sectionneur d'isolation CA sur l'entrée du redresseur (RCB)
- Contacteur CA sur l'entrée de la ligne de by-pass
- Sectionneur d'isolation sur la sortie de l'UPS (OCB)
- Sectionneur d'isolation du by-pass manuel (MBCB) – **En option, externe, pour KEOR HP 400-800 kVA**
- Sectionneur d'isolation / disjoncteur de batterie (BCB) – En option, **externe à l'UPS**
- Bouton d'arrêt d'urgence (EPO)
- Sélecteur normal/by-pass (SW1)
- Panneau de commande LCD



Vérifiez la formation du personnel

L'utilisation des dispositifs de fonctionnement et de contrôle de l'UPS est réservée au personnel autorisé uniquement. Nous vous recommandons de vérifier la formation du personnel en charge de l'utilisation et de la maintenance du système.

3.4.1 Sectionneurs d'isolation (entrée CC et sortie CA)

Les sectionneurs d'isolation qui équipent l'UPS sont utilisés afin d'isoler les composants de puissance de l'appareil de la ligne d'alimentation CA, de la batterie de stockage et des charges.



Tension présente aux bornes

Les sectionneurs d'isolation n'isolent pas complètement l'UPS lorsque les tensions de la ligne CA et de la batterie sont encore présentes au niveau des bornes. Avant toute intervention de maintenance sur l'unité :

- Isolez complètement l'appareil en actionnant les disjoncteurs externes ;
- Patientez au moins 5 minutes afin de permettre la décharge des condensateurs.

3.4.2 Bouton d'arrêt d'urgence (EPO)

Le bouton d'arrêt d'urgence permet de déconnecter immédiatement la sortie de l'UPS, en interrompant l'alimentation des charges. Il entraîne également l'arrêt de l'onduleur.



N'appuyez sur ce bouton qu'en cas de véritable urgence

Les composants du système sont soumis à de fortes contraintes lors de l'utilisation du bouton d'arrêt d'urgence en présence de charge.

- N'appuyez sur le bouton d'arrêt d'urgence qu'en cas de véritable urgence.



By-pass manuel externe

Les systèmes UPS de la gamme KEOR HP 400-800 kVA ne comportent pas de bouton d'arrêt d'urgence local.

L'UPS est également équipé de deux bornes (Eac1-Eac2) permettant le raccordement d'un contact d'arrêt d'urgence distant.

La présence de tension aux bornes de sortie est restaurée dès que le bouton d'arrêt d'urgence ou le contact distant est ramené à sa position initiale.



Réinitialisation de l'alimentation

Réinitialisez l'alimentation en sortie uniquement après avoir éliminé toutes les causes à l'origine de l'arrêt d'urgence et lorsque vous êtes sûr qu'il ne subsiste aucun risque pour les personnes et les biens.

3.4.3 Sélecteur normal/by-pass (SW1)

Le sélecteur normal/by-pass est installé sur le panneau de commande et n'est accessible qu'en ouvrant la porte avant. Il est généralement utilisé lors de la procédure de by-pass manuel, lorsqu'il est nécessaire d'isoler l'UPS pour une intervention de maintenance ou de réparation.



Suivez les procédures indiquées dans le manuel

Le sélecteur normal/by-pass doit être utilisé conformément aux procédures indiquées dans la section relative à l'installation et au démarrage. Le fabricant ne pourra être tenu responsable des dommages liés à une utilisation incorrecte.

3.4.4 Panneau de commande LCD

Le panneau de commande de l'UPS est utilisé pour :

- Vérifier les paramètres de fonctionnement de l'appareil
- Vérifier les alarmes présentes
- Accéder au journal des événements
- Afficher les informations sur l'appareil
- Modifier les paramètres de fonctionnement

Le menu permettant de modifier les paramètres est protégé par un mot de passe afin d'empêcher tout accès par un personnel non autorisé.

4 PANNEAU AVANT

Le panneau avant de l'UPS, composé d'un affichage alphanumérique à deux lignes et de 5 touches de fonction, permet la surveillance complète de l'état de l'UPS.

Le tableau à schéma permet de mieux comprendre l'état de fonctionnement de l'UPS.

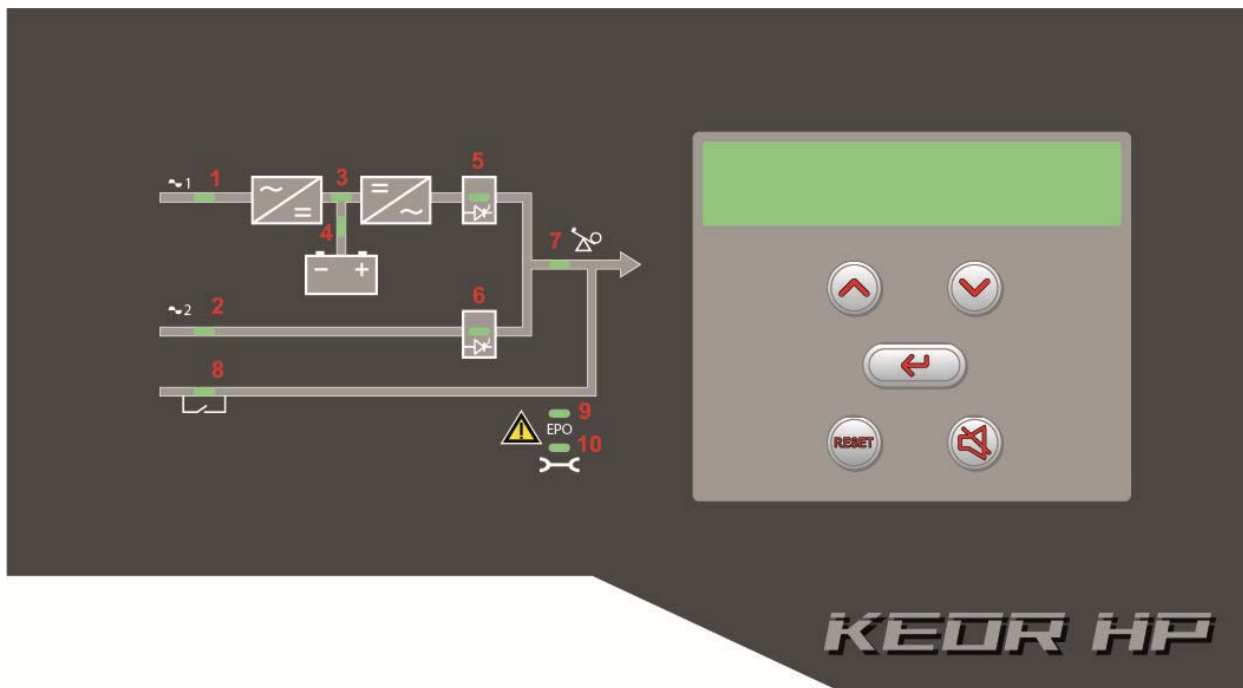

Illustration 6 – Panneau avant de l'UPS

4.1 TOUCHES DE FONCTION

Le panneau avant de l'UPS comporte 5 touches dont les fonctions sont indiquées dans le tableau suivant :

Touche	Fonctions affectées
	<ul style="list-style-type: none"> ➤ Défilement des menus vers le haut ➤ Augmentation de la valeur d'une unité ➤ Sélection d'une valeur
	<ul style="list-style-type: none"> ➤ Défilement des menus vers le bas ➤ Diminution de la valeur d'une unité ➤ Sélection d'une valeur
	<ul style="list-style-type: none"> ➤ Sélection d'un menu ➤ Confirmation des modifications
	<ul style="list-style-type: none"> ➤ Arrêt du buzzer (activé lors d'une alarme ou défaillance)
	<ul style="list-style-type: none"> ➤ Retour au menu précédent.

4.2 FONCTION DES LED DU TABLEAU A SCHEMA

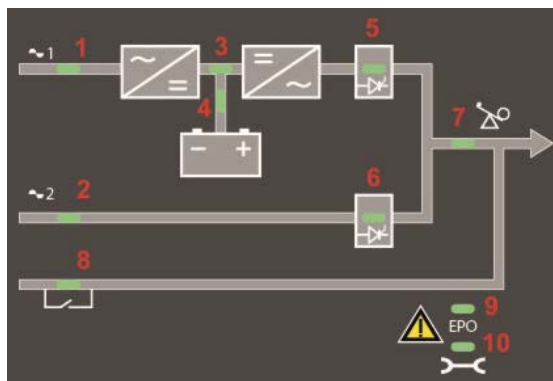



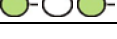

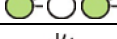









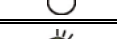











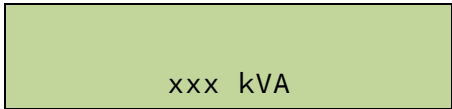
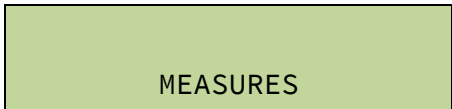

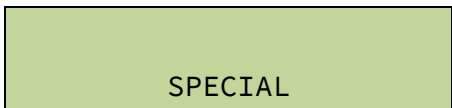
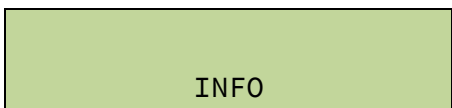

Illustration 7 – Tableau à schéma de l'UPS

LED 1	 VERTE	Ligne CA sur l'entrée du redresseur dans les tolérances
	 VERTE	Mauvaise rotation des phases
	 ÉTEINTE	Défaillance du secteur CA au niveau de l'entrée du redresseur
LED 2	 VERTE	Ligne de by-pass CA dans les tolérances
	 VERTE	Mauvaise rotation des phases
	 ÉTEINTE	Ligne de by-pass CA hors tolérances Défaillance de la ligne de by-pass CA
LED 3	 VERTE	Redresseur arrêté ou défaillant
	 ROUGE	Tension CC hors tolérances
	 VERTE	Redresseur en marche et tension CC dans les tolérances
LED 4	 VERTE	Disjoncteur BCB fermé et batterie en charge
	 VERTE	Batterie en décharge ou en TEST
	 ORANGE	Disjoncteur BCB ouvert
	 ROUGE	Défaut de la batterie (suite à un test de batterie)
	 ÉTEINTE	Batterie indisponible
LED 5	 VERTE	Tension de l'onduleur dans les tolérances et commutateur statique fermé
	 VERTE	Surcharge ou court-circuit de l'onduleur
	 ÉTEINTE	Onduleur arrêté ou tension hors tolérances
LED 6	 ORANGE	Re-transfert bloqué
	 ORANGE	Commutateur de by-pass statique fermé
	 ÉTEINTE	Commutateur de by-pass statique ouvert
LED 7	 VERTE	Disjoncteur de sortie OCB fermé
	 ÉTEINTE	Disjoncteur de sortie OCB ouvert
LED 8	 ORANGE	Commutateur de by-pass manuel MCB fermé
	 ÉTEINTE	Commutateur de by-pass manuel MCB ouvert
LED 9	 ROUGE	Arrêt d'urgence (EPO) actionné
	 ÉTEINTE	Fonctionnement normal
LED 10	 ORANGE	Demande de maintenance (clignotement lent)
	 ORANGE	Alarme critique (clignotement rapide)
	 ÉTEINTE	Fonctionnement normal

5 MANIPULATION DU PANNEAU LCD

5.1 MENUS PRINCIPAUX

	Écran principal (puissance nominale de l'UPS)
	Mesures de l'UPS pour les paramètres de base (tension, courant, etc.)
	État de fonctionnement de l'UPS, éventuelles alarmes présentes et historique des alarmes
	Configuration des paramètres et des fonctions spéciales
	Informations générales concernant l'UPS

5.2 AFFICHAGE DES MESURES

Le menu MEASURES (MESURES) possède la structure suivante :

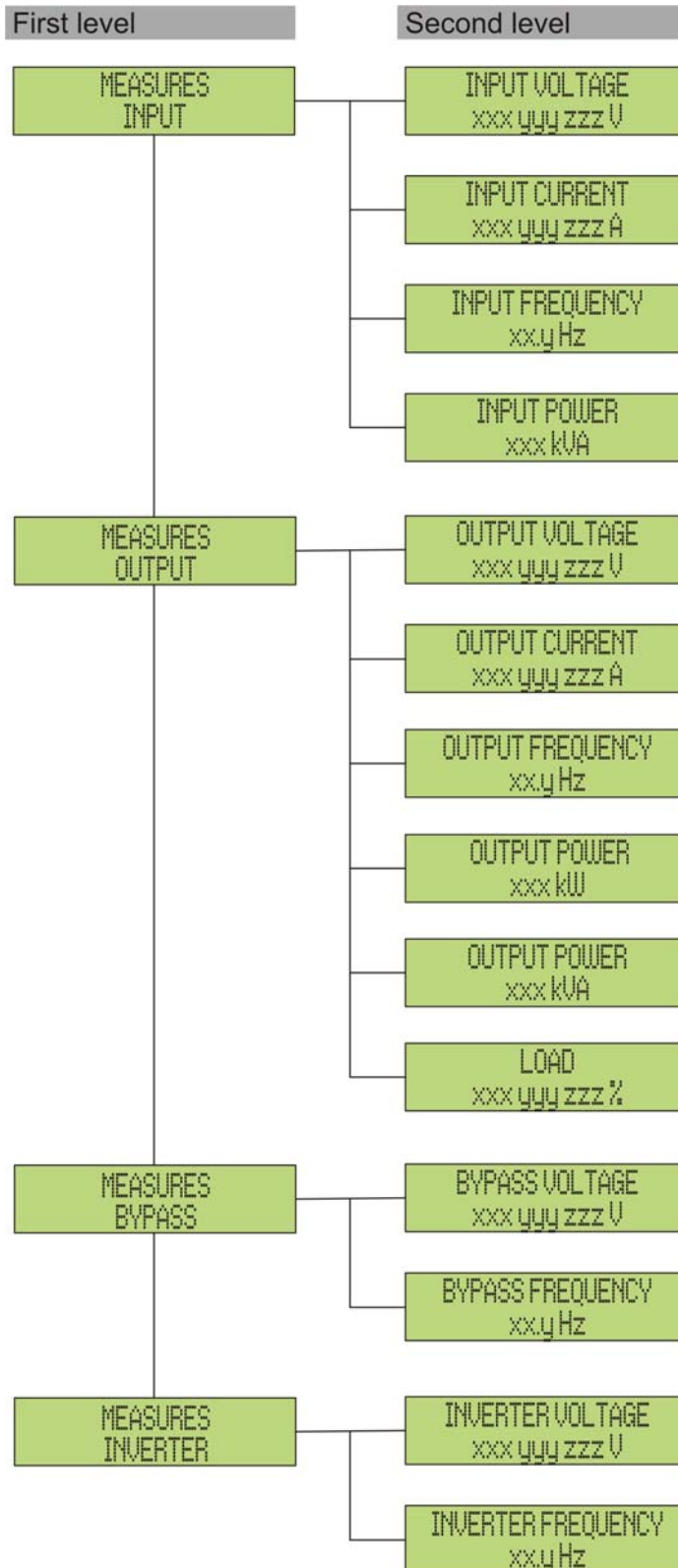

Illustration 8 – Structure du menu MEASURES (MESURES) (1 sur 2)

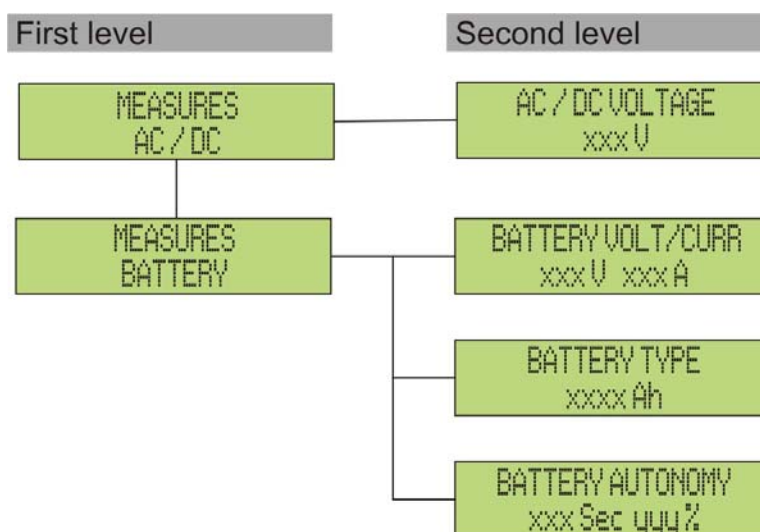

Illustration 9 – Structure du menu MEASURES (MESURES) (2 sur 2)

Sous-menu	Données affichées	Précision
INPUT (ENTRÉE)	Tension d'entrée du redresseur ^{(1) (2)}	1 V
	Courant d'entrée du redresseur ⁽³⁾	1 A
	Fréquence	0,1 Hz
	Puissance en entrée	1 kVA
OUTPUT (SORTIE)	Tension ^{(1) (2)}	1 V
	Courant ⁽³⁾	1 A
	Fréquence	0,1 Hz
	Puissance active	1 kW
	Puissance apparente	1 kVA
	Pourcentage de charge	1 %
BYPASS (BY-PASS)	Tension ^{(1) (2)}	1 V
	Fréquence	0,1 Hz
INVERTER (ONDULEUR)	Tension ^{(1) (2)}	1 V
	Fréquence	0,1 Hz
AC/DC (CA/CC)	Tension en sortie du redresseur	1 V
BATTERY (BATTERIE)	Tension et courant	1 V / 1 A
	Capacité nominale	1 Ah
	Autonomie résiduelle	1 min / 1 %

(1) Les mesures de tension font toujours référence à la valeur phase-neutre

(2) Les trois tensions sont affichées dans un seul écran sous la forme « xxx yyy zzz V »

(3) Les trois courants de ligne sont affichés dans un seul écran sous la forme « xxx yyy zzz A »

5.3 DIAGNOSTICS DE BASE

Le menu ALARMS (ALARMES) permet d'afficher l'état de fonctionnement actuel de l'appareil et d'accéder au journal des événements, en utilisant la structure suivante.

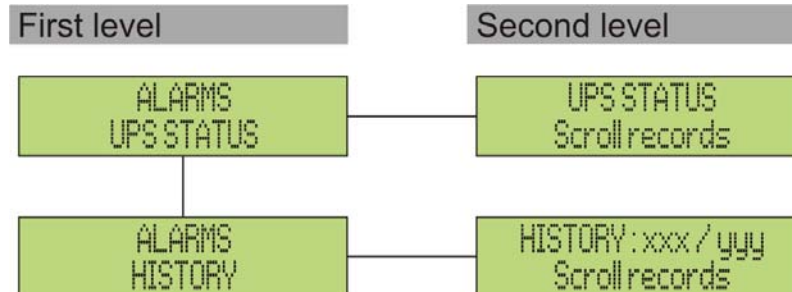

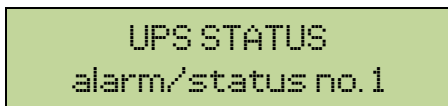

Illustration 10 – Structure du menu ALARMS (ALARMES)

Sous-menu	Données affichées
UPS STATUS (ÉTAT DE L'UPS)	Alarmes présentes et états de fonctionnement
HISTORY (HISTORIQUE)	Journal des événements

Le panneau LCD affiche le menu ALARMS (ALARMES) automatiquement dès qu'une alarme se déclenche. L'indicateur sonore, s'il est sélectionné, est activé afin d'indiquer la survenance d'une défaillance. L'alarme sonore peut être arrêtée en appuyant sur la touche  (BUZZER).



Affichage de la première alarme présente (si aucune alarme n'est présente, l'état de fonctionnement est affiché)

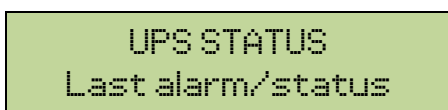

Appuyez sur la touche  pour parcourir le menu et accéder à l'alarme ou à l'état suivant (par ordre alphabétique)



Effacement automatique des alarmes

Si une alarme se déclenche et que les conditions à l'origine de son déclenchement ont été éliminées, l'alarme sera automatiquement annulée et le système redémarré.

5.3.1 Affichage de l'historique des alarmes

Tous les événements sont enregistrés dans l'historique des alarmes.

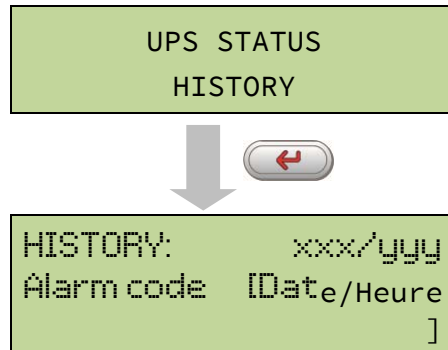

Le premier événement affiché est le plus récent. Tout nouvel événement décale automatiquement tous les autres événements d'une position. L'événement le plus ancien est éliminé.

Le nombre d'événements enregistrés est affiché sur la première ligne (xxx/yyy), qui indique respectivement l'événement actuellement affiché (position dans la liste) et le nombre total d'événements enregistrés (au maximum égal à **250**). Un astérisque indique la réinitialisation automatique de l'alarme.

```
HISTORY:          001/015
A3 *      26-10-10  20:05
```

Dernier événement enregistré (dans l'ordre chronologique)

- Par ex. : réinitialisation automatique de l'alarme « A3 – BOOSTER STOPPED » (A3 - Arrêt du booster)



```
HISTORY:          002/015
A3      26-10-10  19:45
```

Événement immédiatement précédent

- Par ex. : alarme « A3 – BOOSTER STOPPED » (A3 - Arrêt du booster)



```
HISTORY:          015/015
A18     15-10-10  12:49
```

Premier événement enregistré (dans l'ordre chronologique)

5.3.2 Alarmes et états de fonctionnement

ALARMES

A1	MAINS FAULT (Défaut secteur)	A29	MAINTENANCE REQ (Maintenance requise)
A2	INPUT WRONG SEQ (Mauvaise séquence d'entrée)	A30	COMMON ALARM (Alarme commune)
A3	BOOSTER STOPPED (Arrêt du booster)	A31	MBCB BUS CLOSED (Bus MBCB fermé)
A4	BOOSTER FAULT (Défaut du booster)	A32	EPO BUS CLOSED (Bus EPO fermé)
A5	DC VOLTAGE FAULT (Défaut de la tension CC)	A33	ASYMMETRIC LOAD (Charge asymétrique)
A6	BATTERY IN TEST (Batterie en test)	A34	SERVICE REQUIRED (Entretien requis)
A7	BCB OPEN (BCB ouvert)	A35	DIESEL MODE (Mode diesel)
A8	BATTERY DISCHARGE (Décharge de la batterie)	A36	DC FASTSHUTDOWN (Arrêt rapide CC)
A9	BATTERY AUT END (Fin d'autonomie de la batterie)	A37	HIGH TEMP RECT (Température du redresseur élevée)
A10	BATTERY FAULT (Défaut de la batterie)	A38	INV --> LOAD (Onduleur --> charge)
A11	SHORT CIRCUIT (Court-circuit)	A39	INV ERROR LOOP (Erreur boucle onduleur)
A12	STOP TIMEOUT SC (Arrêt, délai de court-circuit écoulé)	A40	SSI FAULT (Défaut SSI)
A13	INV OUT OF TOL (Onduleur hors tolérances)	A41	RECT ERROR LOOP (Erreur boucle redresseur)
A14	BYPASS WR SEQ (Mauvaise séquence de by-pass)	A42	INP FUSES BLOWN (Fusibles d'entrée fondus)
A15	BYPASS FAULT (Défaut de by-pass)	A43	CURR ERROR LOOP (Erreur boucle courant)
A16	BYPASS --> LOAD (By-pass --> charge)	A44	DESAT IGBT INV (Désaturation de l'onduleur IGBT)
A17	RETRANSFER BLOCK (Blocage de retransfert)	A45	HIGH TEMP SSW (Température du commutateur statique élevée)
A18	MBCB CLOSED (MBCB fermé)	A46	PAR LOST REDUND (Perte de redondance parallèle)
A19	OCB OPEN (OCB ouvert)	A47	SEND PARAM ERROR (Erreur d'envoi des paramètres)
A20	OVERLOAD (Surcharge)	A48	RCV PARAM ERROR (Erreur de réception des paramètres)
A21	THERMAL IMAGE (Image thermique)	A49	TEST MODE ERROR (Erreur du mode de test)
A22	BYPASS SWITCH (Commutateur de by-pass)	A50	SSW BLOCKED (Commutateur statique bloqué)
A23	EPO PRESSED (Arrêt d'urgence déclenché)	A51	BATT TEMPERATURE (Température de la batterie)
A24	HITMP INV/DC FUS (Température fusible CC/onduleur élevée)	A53	FIRMWARE ERROR (Erreur du logiciel de l'appareil)

A25	INVERTER OFF (Onduleur arrêté)	A54	CAN ERROR (Erreur CAN)
A26	COMMUNIC ERROR (Erreur de communication)	A55	PAR CABLE DISC (Câble parallèle déconnecté)
A27	EEPROM ERROR (Erreur de l'EEPROM)	A56	MAINS UNBALANCE (Déséquilibre secteur)
A28	CRITICAL FAULT (Défaut critique)	A63	START SEQ BLOCK (Blocage de la séquence de démarrage)

ÉTATS

- S1** BOOSTER OK (Booster OK)
- S2** BATTERY OK (Batterie OK)
- S3** INVERTER OK (Onduleur OK)
- S4** INVERTER --> LOAD
(Onduleur --> charge)
- S5** INV BYPASS SYNC
(Synchronisation by-pass / onduleur)
- S6** BYPASS OK (By-pass OK)
- S7** BYPASS --> LOAD
(By-pass --> charge)
- S8** BOOST CHARGE
(Charge du booster)
- S9** INV MASTER SYNC
(Synchronisation onduleur / maître)



Mode d'affichage et d'enregistrement des alarmes

- Les états sont toujours affichés dans l'ordre ascendant lorsque l'on accède au menu ALARMS – STATUSES (ALARMES - ÉTATS).
- Les alarmes sont affichées lorsqu'elles apparaissent et leur indicateur sonore doit être désactivé à l'aide de la touche buzzer.
- Les alarmes restent affichées tant qu'elles sont présentes. Elles sont automatiquement enregistrées dans le journal d'événements avec la date et l'heure de leur survenance.



Description des alarmes et états

Pour une description plus détaillée des alarmes et des états, voir la section Défauts et alarmes du présent manuel.

6 REGLAGES ET OPERATIONS AVANCEES

Certains paramètres de fonctionnement de l'UPS peuvent être réglés via le menu SPECIAL, dont la structure est la suivante :

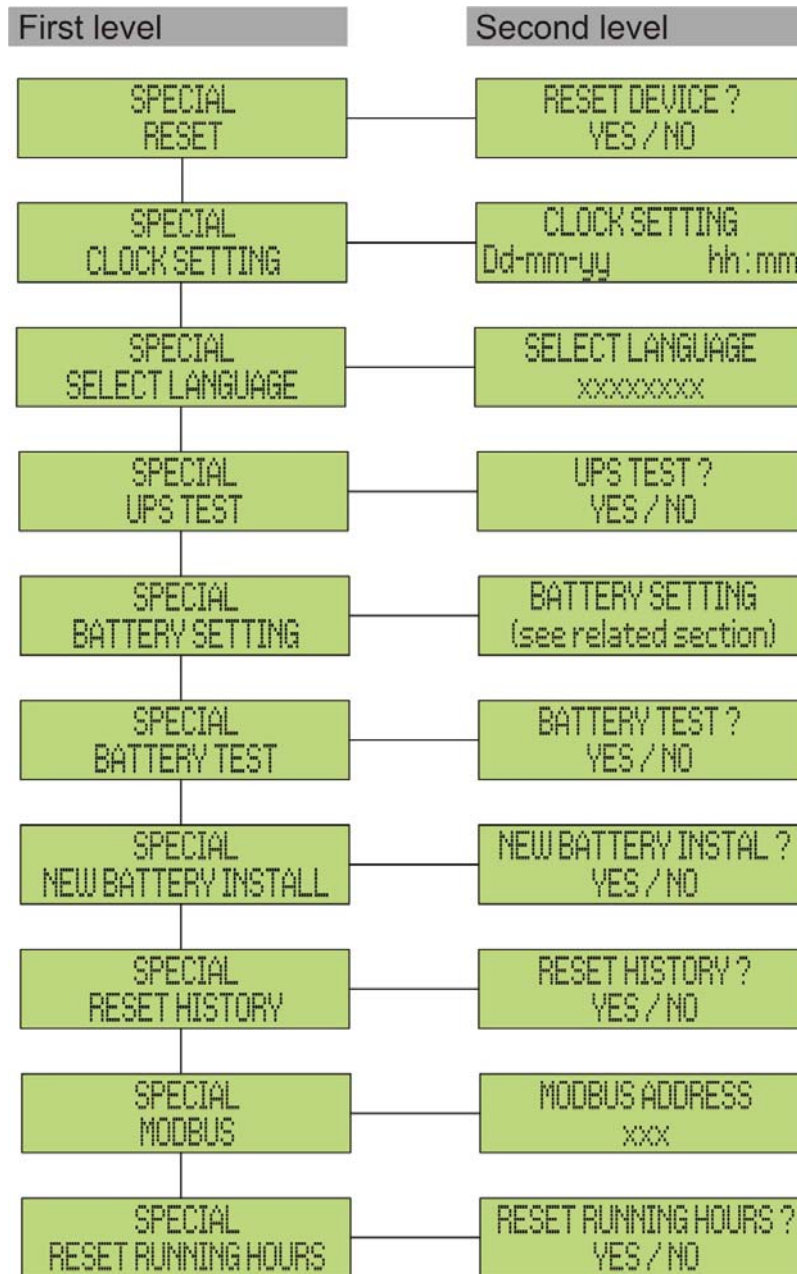

Illustration 11 – Structure du menu SPECIAL

Sous-menu	Données programmables
RESET (RÉinitialiser)	Réinitialisation des conditions de défaillance
CLOCK SETTING (RÉglage de l'horloge)	Date et heure du système
SELECT LANGUAGE (Sélectionner la langue)	Affiche les langues disponibles
UPS TEST (Test de l'UPS)	Effectue un test de commutation
BATTERY SETTING (Réglage de la batterie)	Réglage des paramètres de la batterie
BATTERY TEST (Test de la batterie)	Effectue un test de batterie
NEW BATTERY INSTALL (Installation d'une nouvelle batterie)	Règle l'autonomie à 100 %
RESET HISTORY (Remise à zéro de l'historique)	Remise à zéro du journal des événements
MODBUS	Adresse MODBUS de l'appareil
RESET RUNNING HOURS (Remise à zéro des heures de fonctionnement)	Remise à zéro du compteur d'heures de fonctionnement de l'UPS



Accès protégé par mot de passe

Le menu SETTINGS (Réglages) est protégé par un mot de passe défini en usine afin d'empêcher tout accès par un personnel non autorisé.

- Nous vous recommandons de ne pas divulguer ce mot de passe.
- Les modifications des paramètres de fonctionnement et des opérations de démarrage de l'UPS peuvent se révéler potentiellement dangereuses pour l'appareil et les personnes.

6.1 REGLAGE DE LA DATE ET DE L'HEURE

La date et l'heure peuvent être réglées via le menu CLOCK (Horloge).

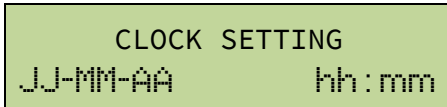

Chaque chiffre peut être modifié à l'aide des flèches (▲ / ▼) et validé à l'aide de la touche ◀ (Entrée).



Réglage correct de la date et de l'heure actuelles

Le réglage correct de la date et de l'heure est essentiel à l'enregistrement du journal des événements.

6.2 AFFICHAGE DES LANGUES DISPONIBLES

Le tableau ci-dessous indique les langues utilisables sur l'appareil.

Paramètre	Valeurs possibles
LANGUAGE (Langue)	ITALIAN (Italien) GERMAN (Allemand) FRENCH (Français) ENGLISH (Anglais) PORTUGUESE (Portugais) SPANISH (Espagnol) POLISH (Polonais) TURKISH (Turc)

Les paramètres peuvent être modifiés en utilisant les flèches (▲ / ▼) pour augmenter les valeurs et la touche ◀ pour valider.

6.3 INSTALLATION D'UNE NOUVELLE BATTERIE

Le menu NEW BATTERY INSTALL (Installation d'une nouvelle batterie) est utilisé lorsque le disjoncteur de batterie BCB n'est pas fermé, lorsque demandé, dans la phase de démarrage. Dans ce cas, le système démarre en considérant que la batterie est complètement déchargée et active l'alarme A10 – BATTERY FAULT (A10 - Défaut de la batterie).

Pour régler l'autonomie de la batterie à 100 %, il est nécessaire d'accéder au menu et de valider avec la touche ◀.



6.4 CONFIGURATION DE LA BATTERIE

Si l'UPS a été testé sans connaître les caractéristiques de la batterie de stockage, le menu BATTERY SETTING (Réglage de la batterie) permet d'indiquer ces caractéristiques. En particulier, les données suivantes peuvent être indiquées :

- Capacité de la batterie en Ampères-heures (Ah)
- Courant de charge en Ampères (A)
- Autonomie nominale en minutes

Accédez au menu en appuyant sur la touche  (Entrée).

BAT CAPACITY SETTING
0120

Chaque chiffre peut être modifié à l'aide des flèches ( / ) et validé à l'aide de la touche  (Entrée).





CONFIRM BATT CAP?
YES

Écran de confirmation du réglage de paramètre



BAT RECHAR CURR SET
18

Chaque chiffre peut être modifié à l'aide des flèches ( / ) et validé à l'aide de la touche  (Entrée).





CONFIRM RECHAR CURR?
YES

Écran de confirmation du réglage de paramètre



AUTONOMY BAT SETTING
0020

Chaque chiffre peut être modifié à l'aide des flèches ( / ) et validé à l'aide de la touche  (Entrée).



CONFIRM AUTON BATT?
YES

Écran de confirmation du réglage de paramètre



SAVE BATT SETTINGS?
YES

Écran de confirmation de la configuration



BATT SETTINGS SAVED
PRESS "ENTER"



Réglage de tous les paramètres

Pour enregistrer tous les paramètres, il est nécessaire d'atteindre la fin de la procédure guidée jusqu'au dernier écran indiqué ci-dessus.

Si la procédure est interrompue avant, aucun des paramètres précédemment réglés ne sera enregistré.

6.5 REGLAGE DES PARAMETRES MODBUS

Les paramètres relatifs à la communication via l'interface RS485 peuvent être réglés dans le menu MODBUS.

➤ Adresse MODBUS

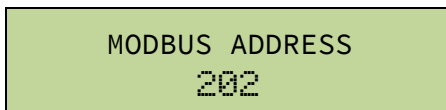

Chaque chiffre peut être modifié à l'aide des flèches (▲ / ▼) et validé à l'aide de la touche ← (Entrée).

Paramètre	Standard	Valeurs possibles
MODBUS ADDRESS (Adresse MODBUS)	1	1 247

6.6 TEST DE L'UPS

Le menu UPS TEST (Test de l'UPS) permet de réaliser un test de commutation de l'onduleur. L'onduleur est arrêté et la charge est transférée sur l'alimentation de by-pass. L'alimentation de l'onduleur est automatiquement restaurée après quelques secondes.

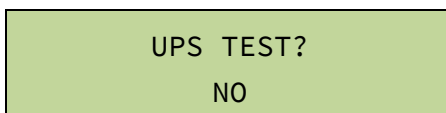

La valeur de la seconde ligne est prête à être modifiée



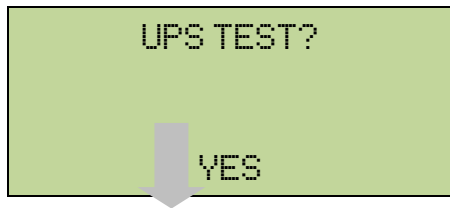

Le paramètre est modifié. La modification est confirmée en appuyant sur ← (Entrée)



Le système effectue un test puis revient à l'écran précédent



Perte d'alimentation possible

En cas de panne de courant en cours de test, le fonctionnement immédiat de l'onduleur n'est pas assuré.

6.7 TEST DE LA BATTERIE

Le menu BATTERY TEST (Test de la batterie) permet de réaliser un court test de décharge de la batterie. Si la batterie n'est pas opérationnelle, l'alarme A10 – Battery fault (A10 - Défaut de la batterie) se déclenche en fin de test.

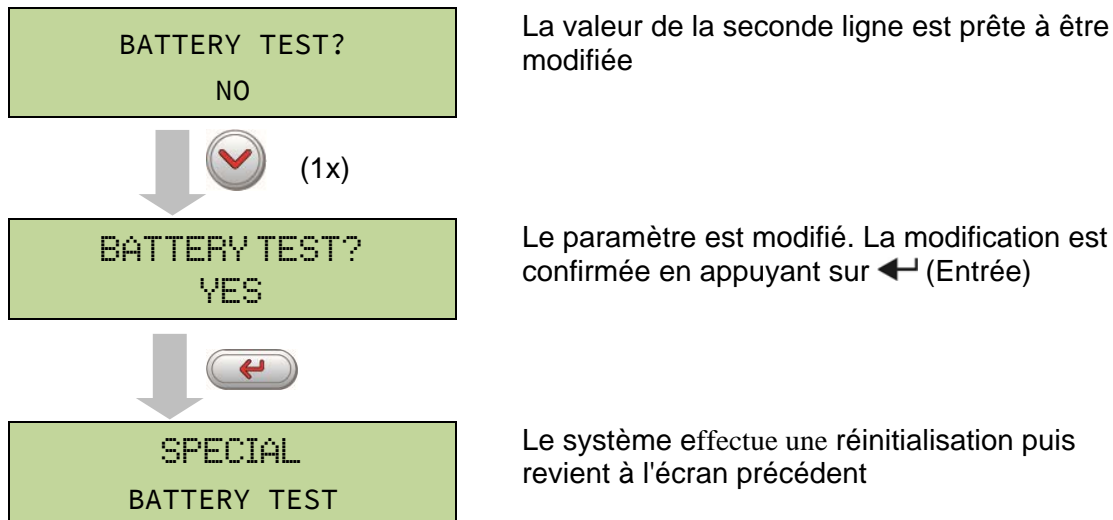

Perte d'alimentation possible

Ce test peut affecter la continuité d'alimentation des charges si la batterie n'est pas complètement chargée.

6.8 RÉINITIALISATION DU SYSTÈME

L'UPS est équipé de protections internes qui bloquent tout ou partie du système. L'alarme peut être effacée et le fonctionnement normal rétabli via le menu RESET (Réinitialiser). Si la défaillance persiste, l'UPS reviendra dans la condition de défaillance précédente.

Dans certains cas, le menu RESET (Réinitialiser) est nécessaire pour la simple réinitialisation d'un signal de défaillance. L'UPS reprend ensuite son fonctionnement.

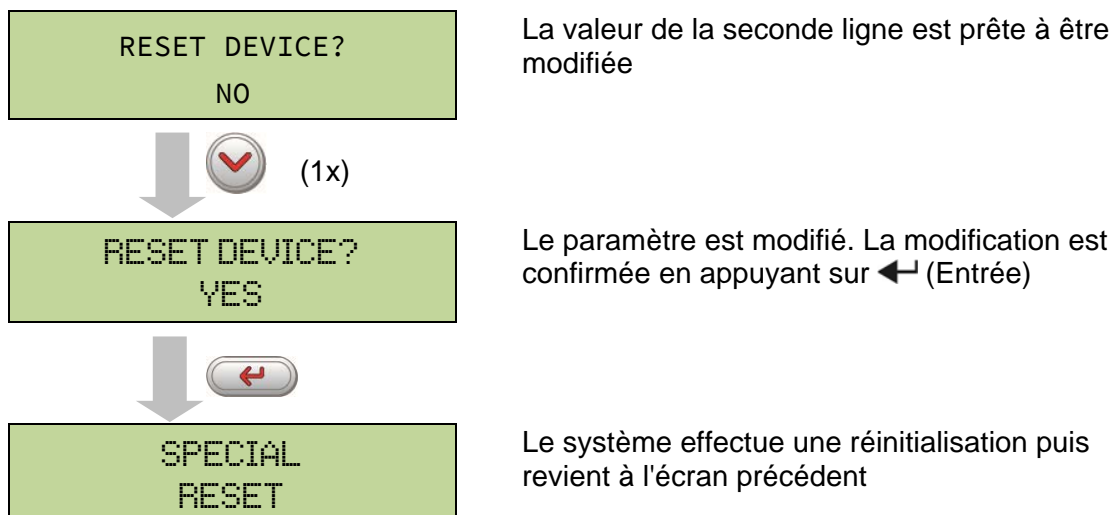

Les conditions de défaillance imposant une réinitialisation manuelle sont :

- Blocage de retransfert du commutateur statique (alarme A17)
- Arrêt de l'onduleur du fait de l'activation du capteur de désaturation IGBT (alarme A44)
- Arrêt de l'onduleur du fait de l'écoulement du délai de court-circuit (alarme 12)
- Arrêt de l'onduleur du fait de la protection contre l'image thermique (alarme 21)
- Arrêt de l'onduleur du fait de l'activation du capteur de déconnexion rapide (alarme A36)
- Arrêt de l'onduleur du fait d'une erreur de la boucle de contrôle de la tension (alarme A39)
- Arrêt du booster du fait d'une erreur de la boucle de contrôle de la tension (alarme A41)
- Arrêt du booster du fait d'une erreur de la boucle de contrôle du courant (alarme A43)
- Commutateur statique bloqué (alarme A50)
- Arrêt du booster du fait de l'activation du capteur de symétrie de charge (alarme A33)
- Activation de l'alarme de défaut de batterie (alarme A10)
- Demande de maintenance programmée (alarme A29).

Pour une description de l'état de l'UPS dans chacune des conditions de défaillance répertoriées ci-dessus, reportez-vous à la section Défauts et alarmes.

6.9 REMISE A ZERO DE L'HISTORIQUE DES ALARMES

Accédez au menu RESET HISTORY (Remise à zéro de l'historique).

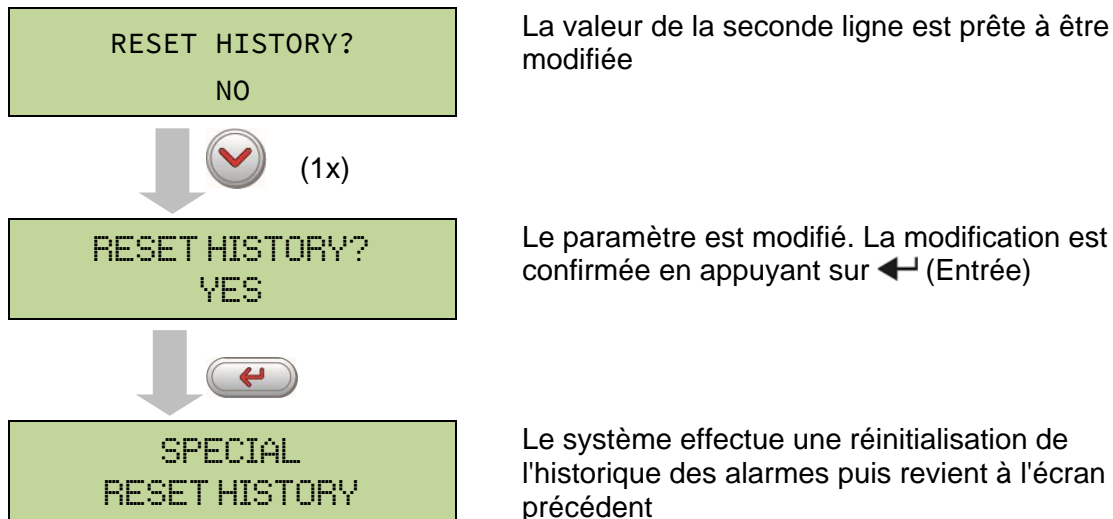

Perte de données

L'historique des alarmes contient des données importantes pour la surveillance du comportement de l'appareil dans le temps. Nous vous recommandons d'enregistrer les données avant toute remise à zéro.

7 INFORMATIONS SYSTÈME

Le menu INFO fournit des informations générales concernant l'UPS. Sa structure est la suivante :

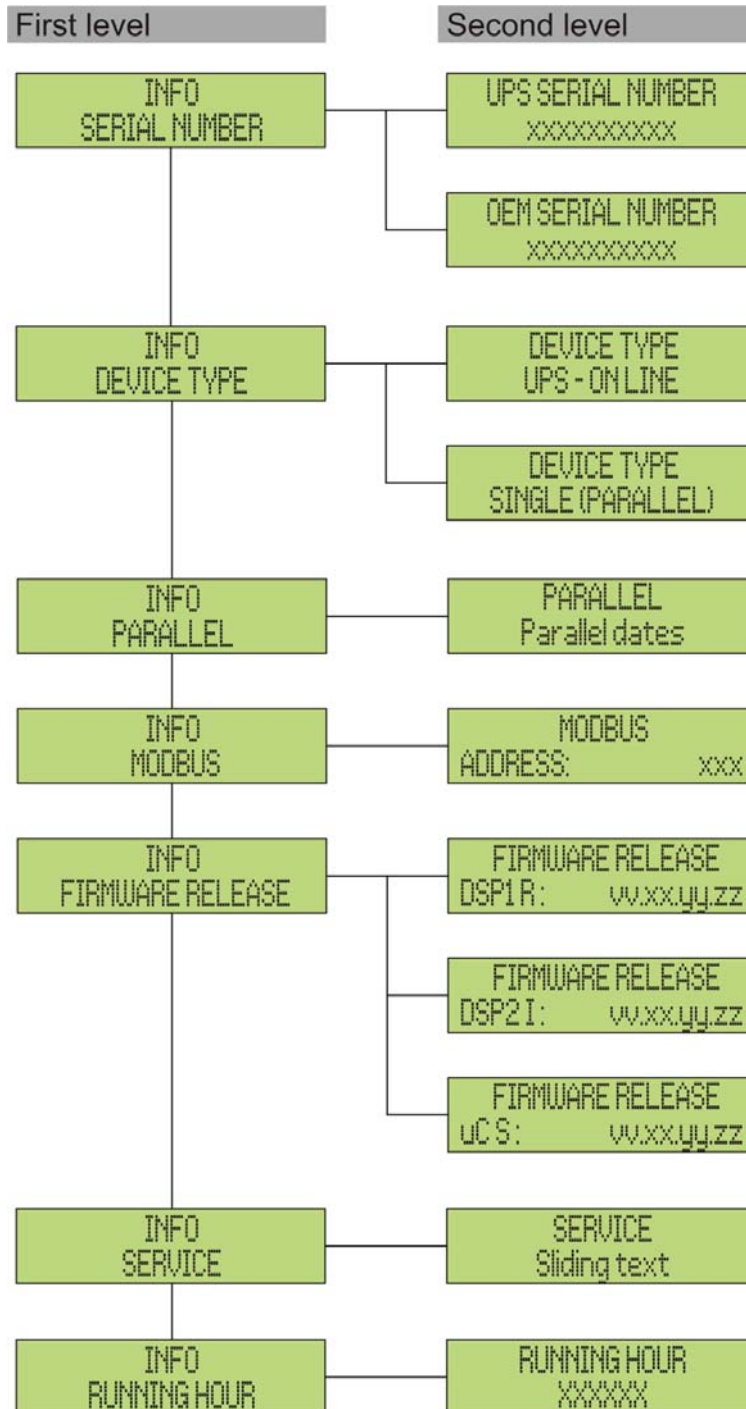

Illustration 12 – Structure du menu INFO

Toutes les données affichées dans les diverses sections sont définies en usine via un logiciel d'interface spécial. Elles ne peuvent pas être modifiées, sauf par un personnel autorisé par le fabricant.

Les seuls paramètres pouvant être modifiés sont les réglages MODBUS (voir le menu SPECIAL).

Sous-menu	Données affichées
SERIAL NUMBER (Numéro de série)	Numéro de série de l'appareil donné par le fabricant et le distributeur OEM, le cas échéant
DEVICE TYPE (Type d'appareil)	Le type d'appareil peut être : <ul style="list-style-type: none"> ➤ ON LINE - UPS (En ligne - UPS) ➤ FREQUENCY CONVERTER (Convertisseur de fréquence) ➤ ECO MODE - UPS (Mode Éco - UPS) ➤ SINGLE UPS (UPS seul) ➤ PARALLEL (Parallèle)
PARALLEL (Parallèle) ⁽¹⁾	Données relatives à la configuration parallèle
MODBUS	Adresse MODBUS de l'appareil
FIRMWARE RELEASE (Version du logiciel de l'appareil)	Version du logiciel installée sur le système
SERVICE (Entretien)	Texte défilant contenant des informations relatives à l'entretien technique
RUNNING HOUR (Heures de fonctionnement)	Dates relatives au nombre d'heures de fonctionnement de l'UPS

⁽¹⁾ Ce menu n'est actif que si l'UPS fait partie d'un système parallèle ou de synchronisation de charge

7.1 INFORMATIONS SUR LE FONCTIONNEMENT EN PARALLELE

Le menu PARALLEL (Parallèle) n'est actif que si l'UPS fait partie d'un système parallèle ou de synchronisation de charge.

7.1.1 Position de l'UPS

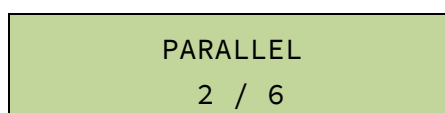

Le premier chiffre de la seconde ligne identifie la *position* de cet UPS spécifique au sein du système parallèle. Le second chiffre représente le nombre total d'UPS.

7.1.2 Hiérarchie maître / esclave

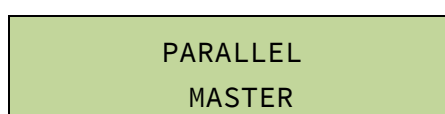

La seconde ligne peut afficher l'une des deux valeurs suivantes : MASTER (Maître) ou SLAVE (Esclave). Un seul *UPS maître* peut être présent dans le système. Dans le cas contraire, il existera un conflit au niveau du bus de communication des données.

7.1.3 Surveillance du bus de communication

```
PARALLEL
1- [ M  2-   3- S  4- S
   ]      S
```

La seconde ligne de ce menu fournit une indication générale concernant la communication entre les unités UPS composant le système.

- Les chiffres représentent les unités UPS.
- Les lettres M et S signifient respectivement MASTER (Maître) et SLAVE (Esclave).
- Les crochets [] autour d'une lettre indiquent l'UPS sur lequel on travaille actuellement.
- Un point d'interrogation en regard d'un chiffre indique que cet UPS ne communique pas sur le bus de données.

Imaginons la situation suivante :

- système composé de 4 UPS ;
- l'UPS 2 est actuellement l'UPS maître ;
- on vérifie la communication des données sur l'UPS 3 ;
- l'UPS 4 ne communique pas.

Le menu affichera les informations suivantes.

```
PARALLEL
1- S  2-   3- [  4- ?
      M  S ]
```

S'il y a plus de quatre appareils en parallèle, le menu affichera les informations suivantes.

```
PARALLEL
1- S  2-   3- [  ....
      M  S ]
```

Les points indiquent la présence d'une autre ligne de menu indiquant l'état des autres UPS du système.

7.1.4 Type de système parallèle

```
PARALLEL
REDUNDANT+x
```

La seconde ligne peut indiquer l'une des deux valeurs suivantes : POWER (Puissance) ou REDUNDANT+x (Redondant + x).

- POWER (Puissance) signifie que le système parallèle nécessite la présence de tous les UPS pour alimenter la charge.

- REDUNDANT+x (Redondant + x) signifie que le système est redondant et possède un indice de redondance x. Par exemple, dans un système composé de 3 UPS, REDUNDANT+2 (Redondant + 2) signifie qu'un seul UPS est nécessaire pour alimenter la charge.

7.1.5 Statistiques relatives aux messages

La section des statistiques relatives aux messages échangés sur les bus de communication se compose de trois menus différents.

```
STATIST CAN SSW
MSG RX: 32564
100.0%
```

Nombre de messages reçus et pourcentage de précision de la réception concernant l'état des commutateurs statiques. Les messages sont échangés entre tous les UPS, par conséquent cette valeur augmentera sur chacun.

```
STATIST CAN INV
SYNC RX: 15849
100.0%
```

Nombre de messages reçus et pourcentage de précision de la réception concernant les signaux de synchronisme. Les messages sont envoyés par l'UPS maître. Par conséquent la valeur augmentera uniquement sur les UPS esclaves.

```
STATIST CAN INV
MSG RX: 9277
99.9%
```

Nombre de messages reçus et pourcentage de précision de la réception concernant l'état du système. Les messages sont échangés entre tous les UPS, par conséquent cette valeur augmentera sur chacun.

7.2 INFORMATIONS RELATIVES À L'ENTRETIEN

Le menu SERVICE (Entretien) fournit des informations importantes concernant l'entretien technique de l'UPS.

Ces informations sont affichées via une chaîne de texte de 60 caractères au maximum qui défile sur la seconde ligne.

Veillez également vous reporter aux adresses et coordonnées indiquées dans le présent manuel.

8 DEFAUTS ET ALARMES

Comme indiqué dans les sections précédentes, le système est doté de diagnostics de base qui permettent une visualisation immédiate des conditions de fonctionnement.

Le panneau LCD affiche immédiatement l'écran des alarmes et un signal sonore se déclenche (si l'option correspondante a été activée). Chaque écran affiche le code alphanumérique de l'alarme et une courte description de l'alarme.

UPS STATUS
A15 BYPASS FAULT

L'affichage indique la première alarme dans l'ordre chronologique



UPS STATUS
A30 COMMON ALARM

Les autres alarmes présentes sont affichées en faisant défiler le menu



UPS STATUS
S1 BOOSTER OK

Après la dernière alarme présente, les états de fonctionnement sont affichés



Risques de blessure liés à un choc électrique !

Avant toute intervention sur l'UPS, assurez-vous que toutes les précautions de sécurité sont respectées :

- toute intervention sur l'unité doit être réalisée par un personnel qualifié ;
- les composants internes ne peuvent être manipulés qu'après déconnexion de l'appareil de ses sources d'alimentation ;
- utilisez toujours des dispositifs de protection conçus pour chaque type d'activité ;
- les instructions contenues dans les manuels doivent être scrupuleusement respectées.
- En cas de doute ou d'impossibilité à résoudre le problème, contactez immédiatement Legrand.

8.1 DEFINITION DES ETATS DE FONCTIONNEMENT

État	S1	BOOSTER OK (Booster OK)
Description	La section du redresseur fonctionne correctement.	
Condition de fonctionnement	Le redresseur alimente l'onduleur et maintient la batterie chargée.	

État	S2	BATTERY OK (Batterie OK)
Description	La batterie est raccordée à l'UPS.	
Condition de fonctionnement	La batterie est maintenue chargée par le redresseur et est prête à alimenter l'onduleur.	

État	S3	INVERTER OK (Onduleur OK)
Description	La tension et la fréquence de l'onduleur sont dans la plage autorisée.	
Condition de fonctionnement	L'onduleur est prêt à alimenter la charge.	

État	S4	INVERTER --> LOAD (Onduleur --> charge)
Description	L'onduleur alimente la charge.	
Condition de fonctionnement	La charge est alimentée par le commutateur d'onduleur statique.	

État	S5	INV BYPASS SYNC (Synchronisation by-pass / onduleur)
Description	L'onduleur est synchronisé avec le by-pass.	
Condition de fonctionnement	La synchronisation entre l'onduleur et le by-pass est verrouillée. Le commutateur statique peut basculer d'une source à l'autre.	

État	S6	BYPASS OK (By-pass OK)
Description	La tension et la fréquence de by-pass sont dans la plage autorisée.	
Condition de fonctionnement	La ligne de by-pass est prête pour le basculement en cas de défaillance de l'onduleur.	

État	S7	BYPASS --> LOAD (By-pass --> charge)
Description	La charge est alimentée par la ligne de by-pass.	
Condition de fonctionnement	La charge est alimentée par le by-pass via le commutateur statique, en attendant le redémarrage de l'onduleur.	

État	S8	BOOST CHARGE (Charge du booster)
Description	La batterie est en charge <i>BOOST</i> .	
Condition de fonctionnement	Le redresseur charge la batterie à une tension plus élevée. Le retour au mode de charge <i>FLOTTANT</i> est automatique.	

État	S9	INV MASTER SYNC (Synchronisation onduleur / maître)
Description	L'onduleur est synchronisé avec l'UPS maître.	
Condition de fonctionnement	Cet état est uniquement présent sur les UPS esclaves. Il indique que l'onduleur est synchronisé avec le signal envoyé par l'UPS maître.	

8.2 DEPANNAGE

Alarme	A1	MAINS FAULT (Défaut secteur)
Description	La tension ou la fréquence de la ligne d'entrée est hors tolérances.	
Causes possibles	<ul style="list-style-type: none"> ➤ Instabilité ou panne secteur. ➤ Mauvaise rotation des phases. 	
Solutions	<ol style="list-style-type: none"> 1. Vérifiez les raccordements au secteur. 2. Vérifiez la stabilité de la tension secteur. 3. Si l'alarme persiste, contactez notre service de support technique. 	

Alarme	A2	INPUT WRONG SEQ (Mauvaise séquence d'entrée)
Description	La rotation des phases sur la ligne d'entrée du redresseur est incorrecte.	
Causes possibles	<ul style="list-style-type: none"> ➤ Mauvais raccordement des câbles d'alimentation. 	
Solutions	<ol style="list-style-type: none"> 1. Vérifiez la rotation des phases. 2. Si l'alarme persiste, contactez notre service de support technique. 	

Alarme	A3	BOOSTER STOPPED (Arrêt du booster)
Description	Le redresseur a été temporairement déconnecté et l'onduleur est alimenté par la batterie.	
Causes possibles	<ul style="list-style-type: none"> ➤ Instabilité de la tension ou de la fréquence de la ligne CA. ➤ Défaut possible du circuit de contrôle du redresseur. 	
Solutions	<ol style="list-style-type: none"> 1. Vérifiez les paramètres de tension de la ligne CA. 2. Redémarrez l'appareil. 3. Si l'alarme persiste, contactez notre service de support technique. 	

Alarme	A4	BOOSTER FAULT (Défaut du booster)
Description	Le redresseur a été déconnecté du fait d'un défaut interne.	
Causes possibles	<ul style="list-style-type: none"> ➤ Défaut possible du circuit de contrôle du redresseur. 	
Solutions	<ol style="list-style-type: none"> 1. Vérifiez les alarmes présentes et exécutez les procédures indiquées. 2. Redémarrez l'appareil. 3. Si l'alarme persiste, contactez notre service de support technique. 	

Alarme	A5	DC VOLTAGE FAULT (Défaut de la tension CC)
Description	La tension CC mesurée est hors tolérances.	
Causes possibles	<ul style="list-style-type: none"> ➤ La batterie a atteint sa tension de décharge du fait d'une panne d'alimentation. ➤ Défaillance du circuit de mesure. 	
Solutions	<ol style="list-style-type: none"> 1. Vérifiez la valeur réelle de la tension CC mesurée. 2. En cas de panne secteur, attendez la restauration de la tension CA. 3. Vérifiez les alarmes présentes et exécutez les procédures indiquées. 4. Redémarrez l'appareil. 5. Si l'alarme persiste, contactez notre service de support technique. 	

Alarme	A6	BATTERY IN TEST (Batterie en test)
Description	La tension du redresseur est réduite afin d'amorcer une courte décharge contrôlée de la batterie.	
Causes possibles	<ul style="list-style-type: none"> ➤ Un test de batterie a été lancé automatiquement (si ce paramètre a été défini) ou manuellement par l'utilisateur. 	
Solutions	<ol style="list-style-type: none"> 1. Attendez la fin du test et vérifiez les éventuels défauts de batterie. 	

Alarme	A7	BCB OPEN (BCB ouvert)
Description	Le sectionneur d'isolation de la batterie est ouvert.	
Causes possibles	<ul style="list-style-type: none"> ➤ Sectionneur d'isolation de la batterie ouvert. 	
Solutions	<ol style="list-style-type: none"> 1. Vérifiez l'état du sectionneur d'isolation de la batterie. 2. Vérifiez la fonctionnalité du contact auxiliaire du sectionneur d'isolation. 3. Vérifiez le raccordement entre le contact auxiliaire du sectionneur d'isolation et les bornes auxiliaires de l'UPS (le cas échéant). 4. Si l'alarme persiste, contactez notre service de support technique. 	

Alarme	A8	BATTERY DISCHARGE (Décharge de la batterie)
Description	La batterie se décharge.	
Causes possibles	<ul style="list-style-type: none"> ➤ La batterie se décharge du fait d'une panne secteur. ➤ Défaillance du redresseur. 	
Solutions	<ol style="list-style-type: none"> 1. Vérifiez les alarmes présentes et exécutez les procédures indiquées. 2. Si l'alarme persiste, contactez notre service de support technique. 	

Alarme	A9	BATTERY AUT END (Fin d'autonomie de la batterie)
Description	La batterie a atteint son niveau de décharge pré-alarme.	
Causes possibles	<ul style="list-style-type: none"> ➤ La batterie se décharge du fait d'une panne secteur. ➤ Défaillance du redresseur. 	
Solutions	<ol style="list-style-type: none"> 1. Vérifiez les alarmes présentes et exécutez les procédures indiquées. 2. Si l'alarme persiste, contactez notre service de support technique. 	

Alarme	A10	BATTERY FAULT (Défaut de la batterie)
Description	Défaut suite à un test de batterie.	
Causes possibles	<ul style="list-style-type: none"> ➤ Défaut de la batterie. 	
Solutions	<ol style="list-style-type: none"> 1. Vérifiez la batterie. 2. Réinitialisez le système. 3. Si l'alarme persiste, contactez notre service de support technique. 	

Alarme	A11	SHORT CIRCUIT (Court-circuit)
Description	Le capteur de courant a détecté un court-circuit à la sortie.	
Causes possibles	<ul style="list-style-type: none"> ➤ Problème de charge. ➤ Défaillance du circuit de mesure. 	
Solutions	<ol style="list-style-type: none"> 1. Vérifiez les charges raccordées à la sortie de l'UPS. 2. Si l'alarme persiste, contactez notre service de support technique. 	

Alarme	A12	STOP TIMEOUT SC (Arrêt, délai de court-circuit écoulé)
Description	Arrêt de l'onduleur du fait d'un court-circuit prolongé lors d'une panne d'alimentation ou du fait d'une surintensité au niveau de l'entrée du pont de l'onduleur.	
Causes possibles	<ul style="list-style-type: none"> ➤ Court-circuit sur les charges pendant une panne d'alimentation. ➤ Défaut du pont de l'onduleur. ➤ Pic de courant temporaire. 	
Solutions	<ol style="list-style-type: none"> 1. Réinitialisez le système. 2. Si l'alarme persiste, contactez notre service de support technique. 	

Alarme	A13	INV OUT OF TOL (Onduleur hors tolérances)
Description	La tension ou la fréquence de l'onduleur est hors tolérances.	
Causes possibles	<ul style="list-style-type: none">➤ Arrêt de l'onduleur du fait d'une alarme.➤ Défaillance de l'onduleur.	
Solutions	<ol style="list-style-type: none">1. Vérifiez les alarmes présentes et exécutez les procédures indiquées.2. Si l'alarme persiste, contactez notre service de support technique.	

Alarme	A14	BYPASS WR SEQ (Mauvaise séquence de by-pass)
Description	La rotation des phases sur la ligne de by-pass est incorrecte.	
Causes possibles	<ul style="list-style-type: none">➤ Mauvais raccordement des câbles d'alimentation.	
Solutions	<ol style="list-style-type: none">1. Vérifiez la rotation des phases.2. Si l'alarme persiste, contactez notre service de support technique.	

Alarme	A15	BYPASS FAULT (Défaut de by-pass)
Description	La tension ou la fréquence de la ligne de by-pass est hors tolérances.	
Causes possibles	<ul style="list-style-type: none">➤ Instabilité ou défaillance de la ligne de by-pass.➤ Mauvaise rotation des phases.	
Solutions	<ol style="list-style-type: none">1. Vérifiez les raccordements au secteur.2. Vérifiez la stabilité de la tension secteur.3. Si l'alarme persiste, contactez notre service de support technique.	

Alarme	A16	BYPASS --> LOAD (By-pass --> charge)
Description	La charge est alimentée par la ligne de by-pass.	
Causes possibles	<ul style="list-style-type: none">➤ Basculement temporaire du fait d'une défaillance de l'onduleur.	
Solutions	<ol style="list-style-type: none">1. Vérifiez l'état de l'onduleur et la présence éventuelle d'autres alarmes.2. Si l'alarme persiste, contactez notre service de support technique.	

Alarme	A17	RETRANSFER BLOCK (Blocage de retransfert)
Description	La charge est bloquée sur la ligne de by-pass.	
Causes possibles	<ul style="list-style-type: none"> ➤ Basculements très fréquents du fait des courants d'appel de charge. ➤ Problèmes de commutateur statique. 	
Solutions	<ol style="list-style-type: none"> 1. Réinitialisez le système. 2. Vérifiez les courants d'appel des charges. 3. Si l'alarme persiste, contactez notre service de support technique. 	

Alarme	A18	MBCB CLOSED (MBCB fermé)
Description	Le sectionneur d'isolation de by-pass manuel est fermé.	
Causes possibles	<ul style="list-style-type: none"> ➤ Sectionneur d'isolation de by-pass manuel fermé. 	
Solutions	<ol style="list-style-type: none"> 1. Vérifiez l'état du sectionneur d'isolation de by-pass manuel. 2. Vérifiez la fonctionnalité du contact auxiliaire du sectionneur d'isolation. 3. Si l'alarme persiste, contactez notre service de support technique. 	

Alarme	A19	OCB OPEN (OCB ouvert)
Description	Le sectionneur d'isolation de la sortie est ouvert.	
Causes possibles	<ul style="list-style-type: none"> ➤ Sectionneur d'isolation de la sortie ouvert. 	
Solutions	<ol style="list-style-type: none"> 1. Vérifiez l'état du sectionneur d'isolation de la sortie. 2. Vérifiez la fonctionnalité du contact auxiliaire du sectionneur d'isolation. 3. Si l'alarme persiste, contactez notre service de support technique. 	

Alarme	A20	OVERLOAD (Surcharge)
Description	Le capteur de courant a détecté une surcharge à la sortie. Si l'alarme persiste, la protection contre les images thermiques sera activée (alarme A21).	
Causes possibles	<ul style="list-style-type: none"> ➤ Surcharge au niveau de la sortie. ➤ Défaillance du circuit de mesure. 	
Solutions	<ol style="list-style-type: none"> 1. Vérifiez les charges raccordées à la sortie de l'UPS. 2. Contactez notre service de support technique. 	

Alarme	A21	THERMAL IMAGE (Image thermique)
Description	La protection contre les images thermiques a été déclenchée après une surcharge prolongée de l'onduleur. L'onduleur est arrêté pendant 30 minutes puis redémarré.	
Causes possibles	<ul style="list-style-type: none"> ➤ Surcharge au niveau de la sortie. ➤ Défaillance du circuit de mesure. 	
Solutions	<ol style="list-style-type: none"> 1. Vérifiez les charges raccordées à la sortie de l'UPS. 2. Si vous devez restaurer immédiatement l'alimentation de l'onduleur, réinitialisez le système. 3. Si l'alarme persiste, contactez notre service de support technique. 	

Alarme	A22	BYPASS SWITCH (Commutateur de by-pass)
Description	Le sélecteur normal/by-pass a été actionné.	
Causes possibles	<ul style="list-style-type: none"> ➤ Opération de maintenance. 	
Solutions	<ol style="list-style-type: none"> 1. Vérifiez la position du sélecteur. 2. Si l'alarme persiste, contactez notre service de support technique. 	

Alarme	A23	EPO PRESSED (Arrêt d'urgence déclenché)
Description	Le système est bloqué du fait de l'activation du bouton d'arrêt d'urgence.	
Causes possibles	<ul style="list-style-type: none"> ➤ Activation du bouton d'arrêt d'urgence (local ou distant). 	
Solutions	<ol style="list-style-type: none"> 1. Relâchez le bouton d'arrêt d'urgence et réinitialisez l'alarme. 2. Si l'alarme persiste, contactez notre service de support technique. 	

Alarme	A24	HITMP INV/DC FUS (Température fusible CC/onduleur élevée)
Description	Température élevée du radiateur du pont de l'onduleur ou déclenchement des fusibles CC protégeant le pont de l'onduleur.	
Causes possibles	<ul style="list-style-type: none"> ➤ Défaut des ventilateurs de refroidissement du radiateur. ➤ La température ambiante ou la température de l'air de refroidissement est trop élevée. ➤ Déclenchement des fusibles de protection CC. 	
Solutions	<ol style="list-style-type: none"> 1. Vérifiez le fonctionnement des ventilateurs. 2. Nettoyez les grilles de ventilation et les filtres à air, le cas échéant. 3. Vérifiez le système de climatisation, le cas échéant. 4. Vérifiez l'état des fusibles CC au niveau de l'entrée du pont de l'onduleur. 5. Si l'alarme persiste, contactez notre service de support technique. 	

Alarme	A25	INVERTER OFF (Onduleur arrêté)
Description	L'onduleur est bloqué du fait d'une défaillance de fonctionnement.	
Causes possibles	➤ Diverses.	
Solutions	<ol style="list-style-type: none"> 1. Réinitialisez le système. 2. Si l'alarme persiste, contactez notre service de support technique. 	

Alarme	A26	COMMUNIC ERROR (Erreur de communication)
Description	Erreur interne.	
Causes possibles	➤ Problèmes de communication au niveau du microcontrôleur.	
Solutions	<ol style="list-style-type: none"> 1. Si l'alarme persiste, contactez notre service de support technique. 	

Alarme	A27	EEPROM ERROR (Erreur de l'EEPROM)
Description	Le contrôleur a détecté une erreur dans les paramètres enregistrés dans l'E ² PROM.	
Causes possibles	➤ Mauvais paramètres saisis lors de la programmation.	
Solutions	<ol style="list-style-type: none"> 1. Contactez notre service de support technique. 	

Alarme	A28	CRITICAL FAULT (Défaut critique)
Description	Une alarme a été déclenchée, entraînant l'arrêt d'une partie de l'UPS (redresseur, onduleur, commutateur statique).	
Causes possibles	➤ Défaillance du système.	
Solutions	<ol style="list-style-type: none"> 1. Vérifiez les alarmes présentes et exécutez les procédures indiquées. 2. Si l'alarme persiste, contactez notre service de support technique. 	

Alarme	A29	MAINTENANCE REQ (Maintenance requise)
Description	Une intervention de maintenance est nécessaire.	
Causes possibles	➤ Le délai limite depuis la dernière intervention de maintenance est écoulé.	
Solutions	<ol style="list-style-type: none"> 1. Contactez notre service de support technique. 	

Alarme	A30	COMMON ALARM (Alarme commune)
Description	Alarme commune.	
Causes possibles	➤ Au moins une alarme s'est déclenchée.	
Solutions	1. Vérifiez les alarmes présentes et exécutez les procédures indiquées.	

Alarme	A31	MBCB BUS CLOSED (Bus MBCB fermé)
Description	Le sectionneur d'isolation de by-pass manuel est fermé.	
Causes possibles	➤ Sectionneur d'isolation de by-pass manuel fermé.	
Solutions	1. Vérifiez l'état du sectionneur d'isolation de by-pass manuel. 2. Vérifiez la fonctionnalité du contact auxiliaire du sectionneur d'isolation. 3. Si l'alarme persiste, contactez notre service de support technique.	

Alarme	A32	EPO BUS CLOSED (Bus EPO fermé)
Description	Le système est bloqué du fait de l'activation du bouton d'arrêt d'urgence.	
Causes possibles	➤ Activation du bouton d'arrêt d'urgence (local ou distant).	
Solutions	1. Relâchez le bouton d'arrêt d'urgence et réinitialisez l'alarme. 2. Si l'alarme persiste, contactez notre service de support technique.	

Alarme	A33	ASYMMETRIC LOAD (Charge asymétrique)
Description	Les tensions positive et négative mesurées entre les condensateurs CC et le point milieu sont différentes.	
Causes possibles	➤ Possible défaillance du circuit de mesure. ➤ Défaut possible des condensateurs CC.	
Solutions	1. Réinitialisez le système. 2. Si l'alarme persiste, contactez notre service de support technique.	

Alarme	A34	SERVICE REQUIRED (Entretien requis)
Description	Une vérification de l'UPS est nécessaire.	
Causes possibles	➤ Défaut possible de l'UPS.	
Solutions	1. Si l'alarme persiste, contactez notre service de support technique.	

Alarme	A35 DIESEL MODE (Mode diesel)
Description	L'UPS est alimenté par le générateur diesel.
Causes possibles	<ul style="list-style-type: none"> ➤ Le contact auxiliaire activant le générateur diesel raccordé à l'UPS est fermé et impose ce mode de fonctionnement.
Solutions	<ol style="list-style-type: none"> 1. Attendez que le générateur diesel s'arrête avec le rétablissement de la tension secteur. 2. Vérifiez le raccordement aux bornes XD1/XD2 du contact auxiliaire signalant le démarrage du générateur diesel. 3. Si l'alarme persiste, contactez notre service de support technique.

Alarme	A36 DC FASTSHUTDOWN (Arrêt rapide CC)
Description	Arrêt de l'onduleur du fait d'un déclenchement du capteur de protection suite à des variations soudaines de la tension CC.
Causes possibles	<ul style="list-style-type: none"> ➤ Défaut de la batterie.
Solutions	<ol style="list-style-type: none"> 1. Vérifiez la batterie. 2. Réinitialisez le système. 3. Si l'alarme persiste, contactez notre service de support technique.

Alarme	A37 HIGH TEMP RECT (Température du redresseur élevée)
Description	Température élevée du radiateur du redresseur.
Causes possibles	<ul style="list-style-type: none"> ➤ Défaut des ventilateurs de refroidissement du radiateur. ➤ La température ambiante ou la température de l'air de refroidissement est trop élevée.
Solutions	<ol style="list-style-type: none"> 1. Vérifiez le fonctionnement des ventilateurs. 2. Nettoyez les grilles de ventilation et les filtres à air, le cas échéant. 3. Vérifiez le système de climatisation, le cas échéant. 4. Si l'alarme persiste, contactez notre service de support technique.

Alarme	A38 INV --> LOAD (Onduleur --> charge)
Description	La charge est alimentée par l'onduleur. Cette alarme est active pour les systèmes UPS en mode « ECO », lorsque l'alimentation préférée est celle issue de la ligne de by-pass.
Causes possibles	<ul style="list-style-type: none"> ➤ Basculement temporaire du fait d'une défaillance de la ligne de by-pass.
Solutions	<ol style="list-style-type: none"> 1. Vérifiez l'état de la ligne de by-pass et la présence éventuelle d'autres alarmes. 2. Si l'alarme persiste, contactez notre service de support technique.

Alarme	A39 INV ERROR LOOP (Erreur boucle onduleur)
Description	Le contrôle n'est pas en mesure de réguler précisément la tension de l'onduleur.
Causes possibles	➤ Défaillance du système de régulation.
Solutions	<ol style="list-style-type: none">1. Réinitialisez le système.2. Si l'alarme persiste, contactez notre service de support technique.

Alarme	A40 SSI FAULT (Défaut SSI)
Description	Le système a détecté une défaillance dans le commutateur statique de l'onduleur.
Causes possibles	<ul style="list-style-type: none">➤ Problèmes possibles au niveau des charges.➤ Défaut du commutateur statique.
Solutions	<ol style="list-style-type: none">1. Vérifiez l'absorption des charges et la présence de composantes CC, le cas échéant, dans le courant CA.2. Si l'alarme persiste, contactez notre service de support technique.

Alarme	A41 RECT ERROR LOOP (Erreur boucle redresseur)
Description	Le contrôle n'est pas en mesure de réguler précisément la tension en sortie du redresseur.
Causes possibles	➤ Défaillance du système de régulation.
Solutions	<ol style="list-style-type: none">1. Réinitialisez le système.2. Si l'alarme persiste, contactez notre service de support technique.

Alarme	A42 INP FUSES BLOWN (Fusibles d'entrée fondus)
Description	Défaillance des fusibles de protection CA au niveau de l'entrée du redresseur.
Causes possibles	➤ Surintensité à l'entrée.
Solutions	<ol style="list-style-type: none">1. Vérifiez les fusibles ainsi que l'état de l'indicateur de fusion.2. Remplacez les fusibles fondus le cas échéant.3. Redémarrez le système.4. Si l'alarme persiste, contactez notre service de support technique.

Alarme	A43 CURR ERROR LOOP (Erreur boucle courant)
Description	Le contrôle n'est pas en mesure de réguler précisément le courant en sortie du redresseur.
Causes possibles	➤ Défaillance du système de régulation.
Solutions	<ol style="list-style-type: none"> 1. Réinitialisez le système. 2. Si l'alarme persiste, contactez notre service de support technique.

Alarme	A44 DESAT IGBT INV (Désaturation de l'onduleur IGBT)
Description	L'onduleur est bloqué du fait de l'activation du capteur de désaturation des pilotes IGBT.
Causes possibles	➤ Défaut du pont de l'onduleur.
Solutions	<ol style="list-style-type: none"> 1. Réinitialisez le système. 2. Si l'alarme persiste, contactez notre service de support technique.

Alarme	A45 HIGH TEMP SSW (Température du commutateur statique élevée)
Description	Température élevée du radiateur du commutateur statique.
Causes possibles	<ul style="list-style-type: none"> ➤ Défaut des ventilateurs de refroidissement du radiateur. ➤ La température ambiante ou la température de l'air de refroidissement est trop élevée.
Solutions	<ol style="list-style-type: none"> 1. Vérifiez le fonctionnement des ventilateurs. 2. Nettoyez les grilles de ventilation et les filtres à air, le cas échéant. 3. Vérifiez le système de climatisation, le cas échéant. 4. Si l'alarme persiste, contactez notre service de support technique.

Alarme	A46 PAR LOST REDUND (Perte de redondance parallèle)
Description	Cette alarme n'est active que sur les systèmes en PARALLÈLE. La continuité n'est pas assurée en cas de défaut de l'un des UPS.
Causes possibles	<ul style="list-style-type: none"> ➤ La charge totale est supérieure à la valeur maximum attendue. ➤ Possible défaillance du circuit de mesure.
Solutions	<ol style="list-style-type: none"> 1. Vérifiez la charge alimentée par le système. 2. Si l'alarme persiste, contactez notre service de support technique.

Alarme	A47	SEND PARAM ERROR (Erreur d'envoi des paramètres)
Description	Erreur interne (MAUVAISE TRANSMISSION DES PARAMÈTRES EEPROM).	
Causes possibles	➤ Problèmes de communication au niveau du microcontrôleur.	
Solutions	1. Contactez notre service de support technique.	

Alarme	A48	RCV PARAM ERROR (Erreur de réception des paramètres)
Description	Erreur interne (ÉCHEC DE LA RÉCEPTION DES PARAMÈTRES EEPROM).	
Causes possibles	➤ Problèmes de communication au niveau du microcontrôleur.	
Solutions	1. Contactez notre service de support technique.	

Alarme	A49	TEST MODE ERROR (Erreur du mode de test)
Description	Erreur interne.	
Causes possibles	➤ Problèmes de communication au niveau du microcontrôleur.	
Solutions	1. Contactez notre service de support technique.	

Alarme	A50	SSW BLOCKED (Commutateur statique bloqué)
Description	Le commutateur statique est bloqué. La charge n'est plus alimentée.	
Causes possibles	<ul style="list-style-type: none"> ➤ Défaillance des charges. ➤ Défaut possible de l'UPS. 	
Solutions	<ol style="list-style-type: none"> 1. Vérifiez les charges afin de détecter une éventuelle défaillance. 2. Réinitialisez le système. 3. Si l'alarme persiste, contactez notre service de support technique. 	

Alarme	A51	BATT TEMPERATURE (Température de la batterie)
Description	La température de la batterie est hors tolérances. Cette alarme n'est active que lorsqu'une sonde de température est installée et activée au niveau de la batterie.	
Causes possibles	<ul style="list-style-type: none"> ➤ Température anormale dans l'armoire de batterie. ➤ Possible défaillance du circuit de mesure. 	
Solutions	<ol style="list-style-type: none"> 1. Vérifiez la température au niveau des batteries et supprimez la cause de l'alarme, le cas échéant. 2. Si l'alarme persiste, contactez notre service de support technique. 	

Alarme	A53	FIRMWARE ERROR (Erreur du logiciel de l'appareil)
Description	Le contrôleur a détecté une incompatibilité au niveau du logiciel de contrôle.	
Causes possibles	<ul style="list-style-type: none"> ➤ La mise à jour du logiciel n'a pas été effectuée correctement. 	
Solutions	1. Contactez notre service de support technique.	

Alarme	A54	CAN ERROR (Erreur CAN)
Description	Erreur interne.	
Causes possibles	<ul style="list-style-type: none"> ➤ Problèmes de communication au niveau du microcontrôleur. 	
Solutions	1. Contactez notre service de support technique.	

Alarme	A55	PAR CABLE DISC (Câble parallèle déconnecté)
Description	Le câble parallèle ne permet pas la communication.	
Causes possibles	<ul style="list-style-type: none"> ➤ Câble parallèle déconnecté ou endommagé. 	
Solutions	<ol style="list-style-type: none"> 1. Vérifiez le raccordement du câble. 2. Contactez notre service de support technique. 	

Alarme	A56	MAINS UNBALANCE (Déséquilibre secteur)
Description	La tension d'entrée du redresseur est déséquilibrée.	
Causes possibles	<ul style="list-style-type: none"> ➤ Problèmes au niveau du réseau de distribution BT ou MT. ➤ Défaut du circuit de mesure. 	
Solutions	<ol style="list-style-type: none"> 1. Vérifiez la tension d'entrée. 2. Contactez notre service de support technique. 	

Alarme	A63	START SEQ BLOCK (Blocage de la séquence de démarrage)
Description	Lors du démarrage de l'UPS, une défaillance a empêché la bonne exécution de la séquence.	
Causes possibles	<ul style="list-style-type: none"> ➤ Dispositifs de commande dans la mauvaise position ou mal utilisés. ➤ Défaut interne possible. 	
Solutions	<ol style="list-style-type: none"> 1. Assurez-vous que les dispositifs de commande (sectionneurs d'isolation, sélecteurs) sont dans la bonne position, telle qu'indiquée dans les procédures (voir la section Installation et démarrage). 2. Si l'alarme persiste, contactez notre service de support technique. 	

LINGUA ITALIANA

1 APPLICABILITÀ

Le istruzioni riportate in questa sezione del manuale sono applicabili ai gruppi statici di continuità indicati di seguito.

- KEOR HP 60kVA
- KEOR HP 80kVA
- KEOR HP 100kVA
- KEOR HP 125kVA
- KEOR HP 160kVA
- KEOR HP 200kVA
- KEOR HP 250kVA
- KEOR HP 300kVA
- KEOR HP 400kVA
- KEOR HP 500kVA
- KEOR HP 600kVA
- KEOR HP 800kVA



Conservazione della documentazione

Questo manuale e tutta la restante documentazione tecnica di supporto al prodotto devono essere conservati, e possibilmente resi accessibili al personale nelle immediate vicinanze dell'UPS.



Informazioni aggiuntive

Nel caso le informazioni riportate nel presente manuale non fossero abbastanza esaurienti si prega di contattare il costruttore del dispositivo, i cui dettagli sono disponibili alla sezione "Contatti".

2 REGOLE E AVVERTENZE DI SICUREZZA



Pericolo di lesioni a seguito shock elettrico

Rispettare sempre tutte le indicazioni relative alla sicurezza, e in particolar modo:

- tutti i lavori sull'apparato devono essere svolti da personale qualificato;
- accedere ai componenti interni solo dopo aver disconnesso il dispositivo dalle sorgenti di alimentazione;
- utilizzare sempre i dispositivi di protezione specifici per ciascun tipo di attività;
- seguire scrupolosamente le istruzioni riportate nei manuali;



Pericolo di lesioni a seguito di guasti al dispositivo

In caso di guasto dell'UPS si possono creare situazioni potenzialmente pericolose.

- Non utilizzare il dispositivo se presenta danni visibili.
- Effettuare regolarmente interventi di manutenzione al fine di rilevare possibili anomalie.



Possibile danneggiamento del dispositivo

Prima di qualsiasi intervento sul dispositivo aver cura di prendere tutte le precauzioni contro le scariche elettrostatiche che potrebbero danneggiare la parte elettronica del sistema.



Leggere la documentazione tecnica

Prima di installare ed utilizzare l'apparecchiatura, assicurarsi di aver letto e compreso tutte le istruzioni contenute nel presente manuale e nella restante documentazione tecnica di supporto.

3 DESCRIZIONE GENERALE DELL'UPS

Gli UPS sono realizzati con tecnologia ad IGBT, ad elevata frequenza di commutazione, per consentire una bassa distorsione della corrente re-iniettata nella rete di alimentazione e un'alta qualità e stabilità della tensione di uscita. La componentistica utilizzata garantisce elevata affidabilità, altissima efficienza e facilità di manutenzione.

3.1 TIPOLOGIA

Gli UPS sono del tipo on-line, doppia conversione; l'inverter facente parte dell'UPS fornisce sempre energia al carico, sia in presenza che in assenza di rete (per il tempo di autonomia della batteria).

Questa configurazione assicura all'utente il miglior servizio, poiché fornisce continuamente energia pulita garantendo la stabilizzazione della tensione e della frequenza ai valori nominali. Inoltre grazie alla doppia conversione, rende il carico completamente immune da micro-interruzioni e da eccessive variazioni della rete, che potrebbero altrimenti danneggiare le utenze (Computer - Strumentazione - Apparecchiature scientifiche ecc.).



Presenza tensione in uscita

La linea connessa con l'uscita UPS è alimentata anche in mancanza della rete per cui, in accordo alle prescrizioni della CEI EN62040-1-2, l'installatore dovrà identificare la linea o le prese alimentate dall'UPS, richiamando l'attenzione dell'utente.



Figura 1 – Schema a blocchi

3.2 DESCRIZIONE DEL SISTEMA

3.2.1 Raddrizzatore

Il Raddrizzatore converte la tensione trifase di rete AC in tensione continua DC.

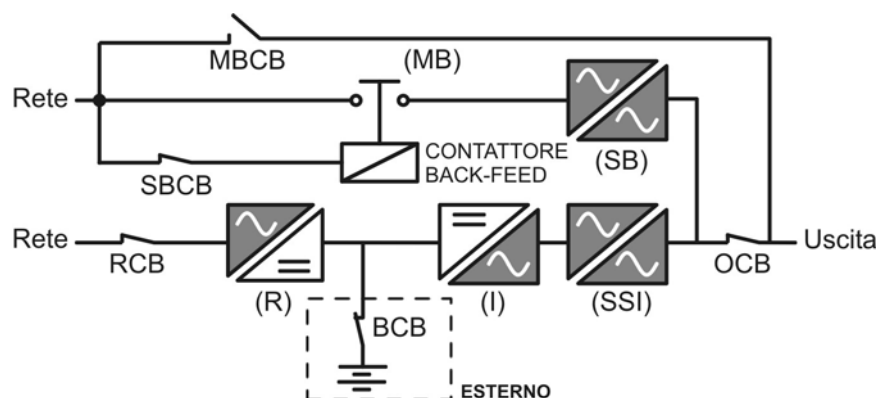
Utilizza un ponte trifase ad IGBT total-controllato a basso assorbimento armonico.

L'elettronica di controllo impiega un μP a 32 bit di ultima generazione che permette di ridurre la distorsione della corrente assorbita dalla rete (THDi) ad un valore inferiore al 5%. Questo garantisce, con riguardo agli altri carichi, che il raddrizzatore non distorca la tensione di rete ed evita il surriscaldamento dei cavi dovuto alla circolazione delle correnti armoniche.

Il raddrizzatore è dimensionato per alimentare l'inverter a pieno carico e la batteria alla massima corrente di ricarica.

3.2.2 Inverter

L'inverter converte la tensione continua proveniente dal raddrizzatore o dalla batteria DC, in tensione alternata AC, stabilizzata in ampiezza e frequenza.

L'inverter è realizzato con tecnologia IGBT in modo da lavorare ad una frequenza elevata di commutazione, circa 10 KHz.

L'elettronica di controllo impiega un μP a 32 bit di ultima generazione che, grazie alla sua potenza di elaborazione, permette di generare una perfetta sinusoide di uscita.

Inoltre il controllo della sinusoide di uscita completamente digitalizzato permette di raggiungere alte prestazioni tra le quali una distorsione in tensione molto bassa anche in presenza di carichi fortemente distorcenti.

3.2.3 Batteria e carica batteria

La batteria viene installata esternamente all'UPS, generalmente essa è contenuta all'interno di un armadio esterno.

La logica del carica-batteria è integrata all'interno dell'elettronica di controllo del raddrizzatore.

La batteria viene sottoposta ad un ciclo di carica, in accordo alle DIN41773, ogni volta che avviene una scarica parziale o totale. Al ripristino della completa capacità viene mantenuto un livello di tensione (tampone) tale da compensare l'auto-scarica.

3.2.4 Bypass statico

Il Bypass Statico permette di commutare il carico fra Inverter e Rete di Emergenza, e viceversa, in tempi brevissimi, ed utilizza SCR come elementi di commutazione di potenza.

3.2.5 Bypass manuale

Il Bypass manuale serve per sezionare completamente l'UPS in caso di manutenzione o disservizio, permettendo allo stesso tempo di alimentare il carico direttamente dalla rete d'ingresso.



Seguire le procedure riportate nel manuale

La manovra di inserimento del bypass manuale e ritorno deve essere eseguita rispettando la procedura riportata nella sezione di installazione e avviamento. Si declina ogni responsabilità da danni derivanti da manovre errate.



Bypass manuale esterno

Negli UPS KEOR HP 400-800kVA il sezionatore di bypass manuale è opzionale ed esterno all'apparato.

3.3 STATI DI FUNZIONAMENTO

L'UPS ha quattro distinte modalità operative, descritte di seguito:

- Funzionamento normale
- Funzionamento da bypass
- Funzionamento da batteria
- Bypass manuale

3.3.1 Funzionamento normale

Durante il funzionamento normale tutti gli interruttori/sezionatori sono chiusi, eccetto MCB (bypass di manutenzione).

Il raddrizzatore è alimentato dalla tensione di ingresso trifase AC, alimenta a sua volta l'inverter e compensa le variazioni della tensione di rete così come quelle di carico, mantenendo la tensione DC costante. Allo stesso tempo provvede a tenere la batteria in carica (tampono o rapida in funzione del tipo di batteria). L'inverter converte la tensione DC in una sinusoide AC, stabilizzata in tensione e frequenza, e provvede ad alimentare il carico tramite il suo static switch SSI.



Figura 2 – Funzionamento normale

3.3.2 Funzionamento da bypass

Il carico può essere trasferito sotto bypass sia automaticamente che manualmente. Il trasferimento manuale è dovuto al BYPASS SWITCH, che forza il carico su bypass. In caso di guasto della linea di bypass, il carico è trasferito nuovamente sotto inverter senza interruzione.

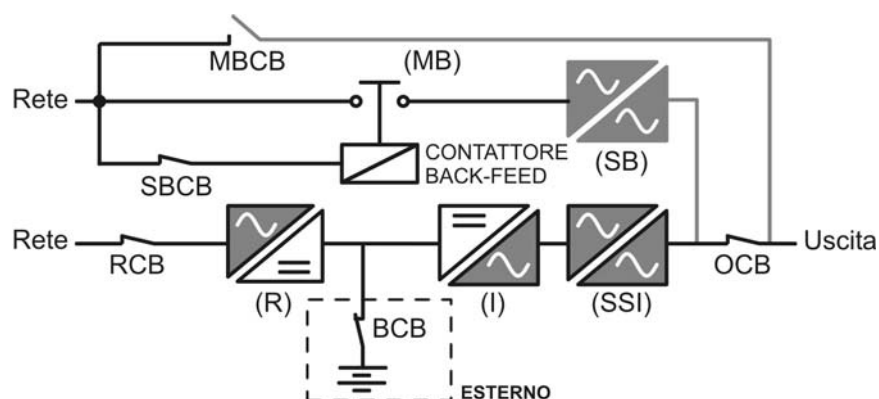

Figura 3 – Carico alimentato da bypass

3.3.3 Funzionamento da batteria

In caso di mancanza rete, o guasto raddrizzatore la batteria provvede senza interruzione ad alimentare l'inverter. La tensione di batteria scende in funzione dell'ampiezza della corrente di scarica; la caduta di tensione non ha alcun effetto sulla tensione di uscita che è tenuta costante variando la modulazione PWM. Un allarme viene attivato quando la batteria si avvicina al valore minimo di scarica.

Nel caso l'alimentazione venga ripristinata prima che la batteria sia completamente scarica, il sistema si riporta automaticamente in funzionamento normale. Nel caso inverso, l'inverter si arresta e il carico viene trasferito alla rete di bypass (funzionamento da bypass). Se la rete di bypass non è disponibile o fuori dai limiti di tolleranza l'alimentazione ai carichi viene interrotta appena la batteria raggiunge la soglia limite di scarica (*black-out*).

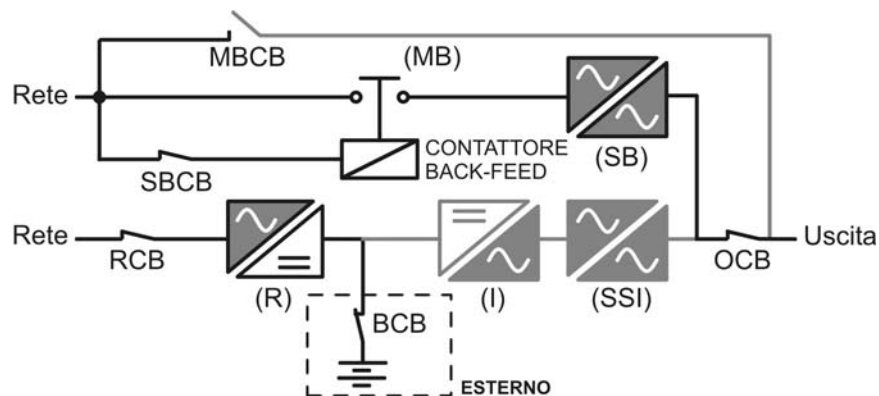
Appena viene ripristinata l'alimentazione il raddrizzatore provvede alla ricarica della batteria. Nella configurazione standard l'alimentazione ai carichi viene ripristinata appena la rete è nuovamente disponibile, ed avviene tramite l'interruttore statico SSB. Il riavvio dell'inverter avviene quando la batteria ha ripristinato parte della sua capacità.

La ripartenza del sistema dalla condizione di *black-out* può essere personalizzata sulla base delle esigenze dell'impianto in tre modalità differenti:

- Bypass → i carichi vengono alimentati appena la rete di bypass è disponibile (configurazione di fabbrica).
- Inverter → i carichi vengono alimentati dall'inverter (anche se la rete di bypass è disponibile) quando la tensione di batteria ha raggiunto la soglia programmata, successivamente al riavvio del raddrizzatore.
- Inverter Man. → l'alimentazione in uscita NON viene ripristinata automaticamente; il sistema chiede conferma del riavvio, che può essere effettuato solo manualmente da un operatore tramite pannello frontale.



Figura 4 – Funzionamento da batteria

3.3.4 Bypass manuale

Il funzionamento in bypass manuale è necessario ogni volta che si voglia provare la funzionalità dell'UPS, oppure durante lavori di manutenzione o riparazione.

Durante il bypass manuale per riparazione o manutenzione l'UPS è completamente spento e il carico è alimentato direttamente dalla rete di bypass.

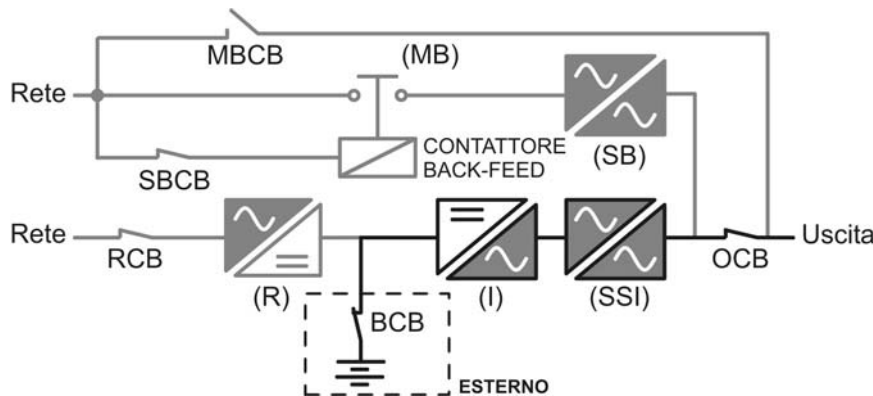

Seguire le procedure riportate nel manuale

La manovra di inserimento del bypass manuale e ritorno deve essere eseguita rispettando la procedura riportata nella sezione di installazione e avviamento. Si declina ogni responsabilità da danni derivanti da manovre errate.



Bypass manuale esterno

Negli UPS KEOR HP 400-800kVA il sezionatore di bypass manuale è opzionale ed esterno all'apparato.



Figura 5 – By-pass manuale

3.4 COMANDI E ORGANI DI MANOVRA

I comandi e gli organi di manovra dell'UPS sono indicati di seguito:

- Sezionatore AC ingresso raddrizzatore (RCB)
- Contattore AC ingresso linea di bypass
- Sezionatore uscita UPS (OCB)
- Sezionatore di bypass manuale (MBCB) – **Opzionale esterno per KEOR HP 400-800kVA**
- Sezionatore / Interruttore di batteria (BCB) – Opzionale, **esterno all'UPS**
- Pulsante di arresto di emergenza (EPO)
- Selettore Normale/Bypass (SW1)
- Pannello di comando LCD

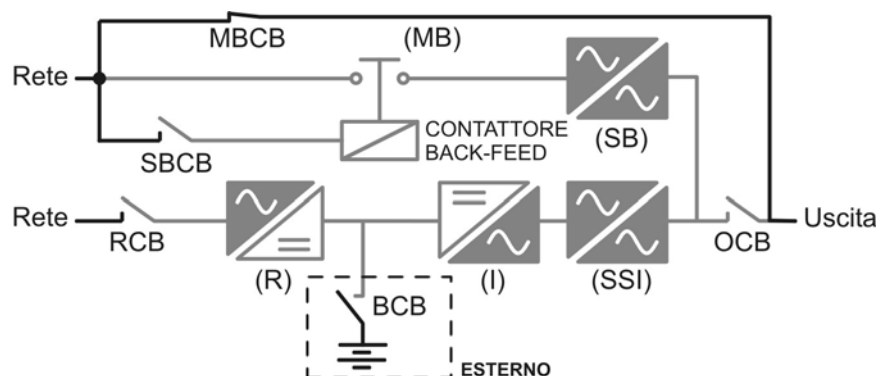

Verificare l'addestramento del personale

L'utilizzo degli organi di manovra e comando dell'UPS è destinato a personale autorizzato. Si consiglia di verificare l'addestramento del personale addetto all'utilizzo e alla manutenzione del sistema.

3.4.1 Sezionatori (ingresso DC e uscita AC)

I sezionatori previsti sull'UPS servono per isolare la parte di potenza del dispositivo dalla rete AC di alimentazione, dalla batteria di accumulatori e dai carichi.



Presenza di tensione sui terminali

I sezionatori non isolano completamente l'UPS, all'interno del quale sono ancora presenti le tensioni della rete AC e della batteria sui terminali. Prima di effettuare qualsiasi intervento di manutenzione sull'apparato provvedere a:

- isolare completamente il dispositivo azionando gli interruttori esterni;
- attendere almeno 5 minuti per far scaricare i condensatori.

3.4.2 Pulsante di arresto di emergenza (EPO)

Il pulsante di arresto di emergenza viene utilizzato per disconnettere immediatamente l'uscita dell'UPS disalimentando i carichi e provvede inoltre a spengere l'inverter.



Azionare il pulsante solo in caso di vera emergenza

I componenti del sistema vengono sollecitati fortemente in caso di manovra del pulsante di arresto di emergenza sotto carico.

- Utilizzare il pulsante di arresto di emergenza solo in caso di vera emergenza.



Bypass manuale esterno

Negli UPS KEOR HP 400-800kVA il pulsante di arresto di emergenza locale non è previsto.

L'UPS è inoltre provvisto di due morsetti (Eac1-Eac2) sui quali è possibile collegare un eventuale contatto di arresto di emergenza remoto.

La presenza di tensione sui morsetti di uscita viene ripristinata appena il pulsante di arresto, oppure il contatto remoto, viene riportato nella posizione iniziale.



Ripristino alimentazione

Ripristinare l'alimentazione in uscita solamente quando le cause che hanno portato all'arresto di emergenza sono state eliminate e si è certi che non ci siano pericoli per le persone o le cose.

3.4.3 Selettore Normale/Bypass (SW1)

Il selettore Normale/Bypass è montato all'interno del quadro ed è accessibile solamente aprendo la porta frontale. Viene generalmente utilizzato durante la procedura di bypass manuale, quando è necessario isolare l'UPS per manutenzione o riparazione.



Seguire le procedure riportate nel manuale

Il selettore Normale/Bypass deve essere manovrato solamente in accordo alle procedure riportate nella sezione di installazione e avviamento. Si declina ogni responsabilità da danni derivanti da manovre errate.

3.4.4 Pannello di comando LCD

Il pannello di comando dell'UPS è utilizzato per:

- Verificare i parametri di funzionamento del dispositivo
- Verificare gli allarmi presenti
- Accedere allo storico eventi
- Visualizzare le informazioni sul dispositivo
- Modificare parametri operativi

Il menù che permette la modifica dei parametri è protetto da password per evitarne l'accesso a personale non autorizzato.

4 PANNELLO FRONTALE

Il pannello frontale dell'UPS è composto da un display alfanumerico a 2 righe più 5 tasti funzione e consente il completo monitoraggio dello stato dell'UPS.

Il sinottico di flusso agevola la comprensione dello stato di funzionamento.



Figura 6 – Pannello frontale UPS

4.1 TASTI FUNZIONE

Il pannello frontale dell'UPS è provvisto di 5 tasti, le cui funzioni sono indicate nella tabella seguente:

Tasto	Funzioni assegnate
	<ul style="list-style-type: none"> ➤ Scorre i menu verso l'alto ➤ Incrementa i valori di una unità ➤ Seleziona un valore
	<ul style="list-style-type: none"> ➤ Scorre i menu verso il basso ➤ Decrementa i valori di una unità ➤ Seleziona un valore
	<ul style="list-style-type: none"> ➤ Seleziona un menu ➤ Conferma le modifiche
	<ul style="list-style-type: none"> ➤ Silenzia il buzzer (attivato a seguito di un allarme o anomalia)
	<ul style="list-style-type: none"> ➤ Torna al menu precedente

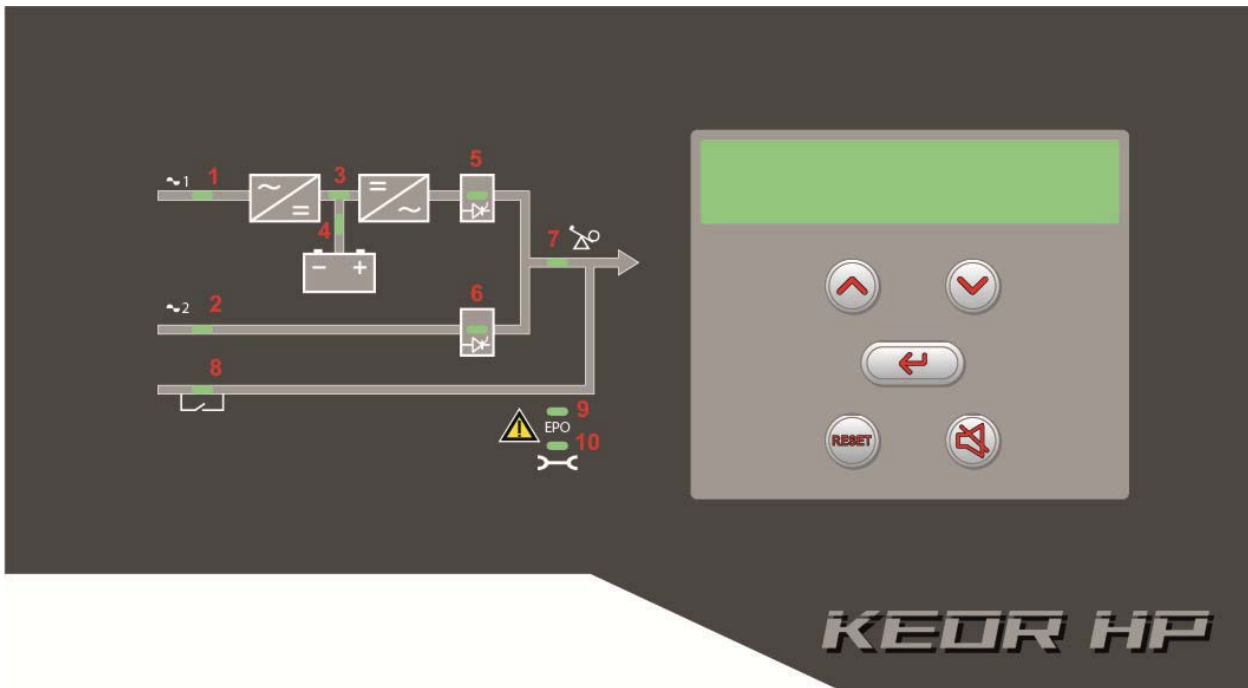
4.2 FUNZIONE DEI LED DEL SINOTTICO











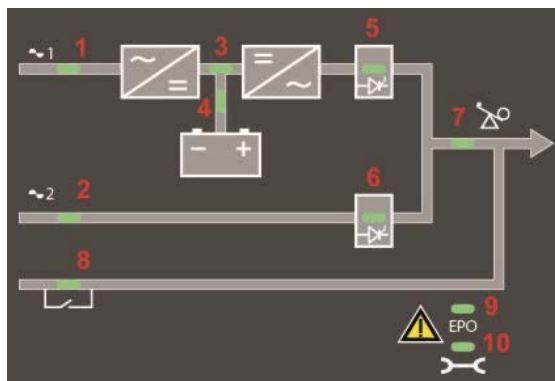





















Figura 7 – Sinottico UPS

LED 1		VERDE	Rete AC ingresso raddrizzatore in tolleranza
		VERDE	Senso ciclico errato
		OFF	Mancanza rete AC ingresso raddrizzatore
LED 2		VERDE	Rete AC bypass in tolleranza
		VERDE	Senso ciclico errato
		OFF	Rete AC bypass fuori tolleranza Mancanza rete AC bypass
LED 3		VERDE	Raddrizzatore spento oppure guasto
		ROSSO	Tensione DC fuori tolleranza
		VERDE	Raddrizzatore acceso e tensione DC in tolleranza
LED 4		VERDE	Interruttore BCB chiuso e batteria in carica
		VERDE	Batteria in scarica o in TEST
		ARANCIO	Interruttore BCB aperto
		ROSSO	Batteria guasta (a seguito test di batteria)
		OFF	Batteria non presente
LED 5		VERDE	Tensione inverter in tolleranza e static switch chiuso
		VERDE	Sovraccarico inverter o corto circuito
		OFF	Inverter spento o tensione fuori tolleranza
LED 6		ARANCIO	Ritrasferimento bloccato
		ARANCIO	Static switch bypass chiuso
		OFF	Static switch bypass aperto
LED 7		VERDE	Interruttore di uscita OCB chiuso
		OFF	Interruttore di uscita OCB aperto
LED 8		ARANCIO	Interruttore di bypass manuale MCB chiuso
		OFF	Interruttore di bypass manuale MCB aperto
LED 9		ROSSO	Arresto di emergenza (EPO) attivato
		OFF	Funzionamento normale
LED 10		ARANCIO	Richiesta intervento di manutenzione (lampeggio lento)
		ARANCIO	Allarme critico (lampeggio veloce)
		OFF	Funzionamento normale

5 GESTIONE DEL PANNELLO LCD

5.1 MENU PRINCIPALI

xxx kVA	Visualizza la potenza nominale dell' UPS.
MISURE	Misure dei parametri fondamentali dell'UPS (tensione, corrente, ecc.)
ALLARMI	Stato di funzionamento dell'UPS, eventuali allarmi presenti e storico allarmi
SPECIALE	Impostazione parametri e funzioni speciali
INFO	Informazioni generali sull'UPS

5.2 VISUALIZZAZIONE DELLE MISURE

Il menu MISURE è strutturato come segue:



Figura 8 – Struttura menu MISURE (1 di 2)



Figura 9 – Struttura menu MISURE (2 di 2)

Sotto-menu	Dati visualizzati	Accuratezza
INGRESSO	Tensione ingresso raddrizzatore ^{(1) (2)}	1 V
	Corrente ingresso raddrizzatore ⁽³⁾	1 A
	Frequenza	0,1 Hz
	Potenza di ingresso	1 kVA
USCITA	Tensione ^{(1) (2)}	1 V
	Corrente ⁽³⁾	1 A
	Frequenza	0,1 Hz
	Potenza attiva	1 kW
	Potenza apparente	1 kVA
	Percentuale di carico	1 %
BYPASS	Tensione ^{(1) (2)}	1 V
	Frequenza	0,1 Hz
INVERTER	Tensione ^{(1) (2)}	1 V
	Frequenza	0,1 Hz
AC / DC	Tensione uscita raddrizzatore	1 V
BATTERIA	Tensione e corrente	1 V / 1 A
	Capacità nominale	1 Ah
	Autonomia residua	1 min / 1 %

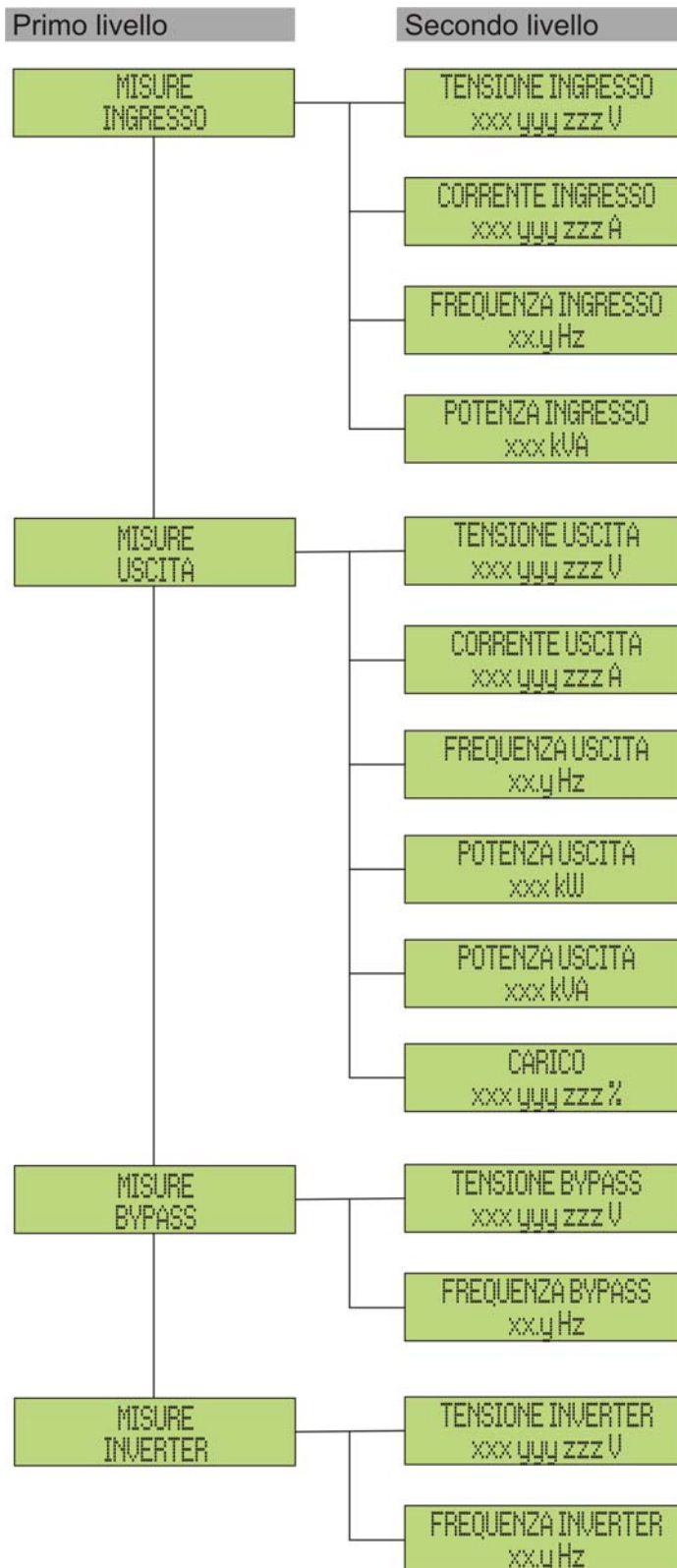
(1) Le misure di tensione sono sempre riferite tra fase e neutro

(2) Le tre tensioni sono visualizzate in una schermata unica nella forma "xxx yyy zzz V"

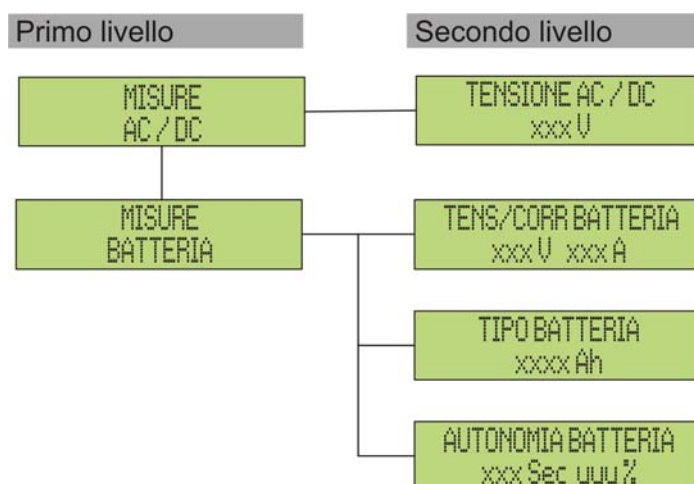
(3) Le tre correnti di linea sono visualizzate in una schermata unica nella forma "xxx yyy zzz A"

5.3 DIAGNOSTICA DI BASE

Dal menu ALLARMI è possibile visualizzare lo stato di funzionamento attuale del dispositivo ed accedere allo storico eventi, secondo la seguente struttura.





Figura 10 – Struttura menu allarmi

Sotto-menu	Dati visualizzati
STATO UPS	Allarmi presenti e stati di funzionamento
STORICO	Storico eventi

Il pannello LCD si porta automaticamente al menu ALLARMI ogni volta che si verifica un allarme; il segnalatore acustico, se abilitato, viene attivato per indicare l'avvenuta anomalia. La tacitazione viene effettuata premendo il pulsante  (BUZZER).

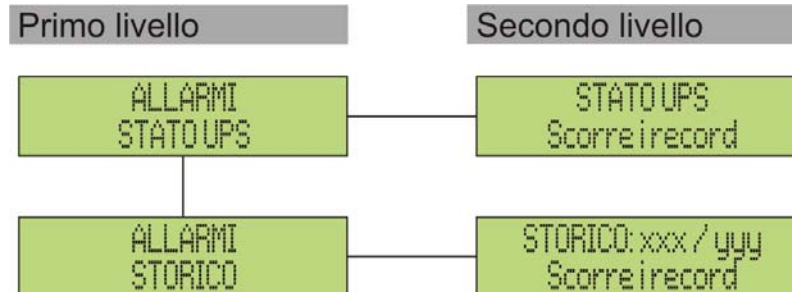

Visualizzazione del primo allarme presente (se non presenti allarmi visualizzazione dello stato di funzionamento)



Premendo il tasto  si scorre il menu e si passa all'allarme/stato successivo (in ordine alfabetico)



Cancellazione automatica allarmi

Nell'eventualità che un allarme si presenti e poi vengano meno le condizioni che lo hanno provocato, la cancellazione è automatica, così come il riavvio del sistema.

5.3.1 Visualizzazione dello storico allarmi

Tutti gli eventi vengono registrati nello storico.

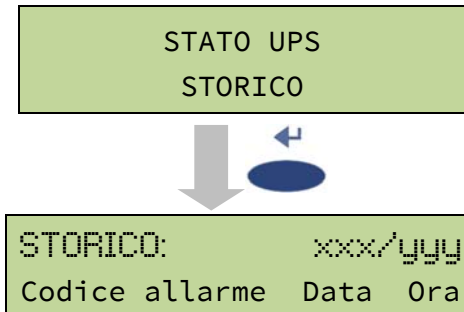

Il primo evento visualizzato è l'ultimo in ordine di tempo; un nuovo evento fa scorrere automaticamente gli altri di una posizione ed elimina l'evento più vecchio.

La quantità di eventi memorizzati è visualizzata sulla prima riga (xxx/yyy), dove sono riportati rispettivamente il dato visualizzato al momento (posizione nella lista) e il numero totale di dati memorizzati (numero massimo pari a **250**). Un asterisco indica il reset automatico dell'allarme.

A screenshot of the alarm history screen. The first line shows "STORICO: 001/015". The second line shows "A3 * 26-10-10 20:05". A large grey arrow points downwards from this screen to the next one.

Ultimo evento memorizzato (in ordine di tempo)

- Es.: reset automatico allarme "A3 – RADD SPENTO"

A screenshot of the alarm history screen. The first line shows "STORICO: 002/015". The second line shows "A3 26-10-10 19:45". A large grey arrow points downwards from this screen to the next one.

Evento immediatamente precedente

- Es.: allarme "A3 – RADD SPENTO"

A screenshot of the alarm history screen. The first line shows "STORICO: 015/015". The second line shows "A18 15-10-10 12:49".

Primo evento memorizzato (in ordine di tempo)

5.3.2 Lista degli allarmi e degli stati

ALLARMI

A1	MANCANZA RETE	A29	MANUTENZ PROGRAM
A2	ER SENSO CICL ING	A30	ALLARME GENERALE
A3	RADD SPENTO	A31	MBCB BUS CHIUSO
A4	ANOMALIA RADD	A32	EPO BUS
A5	TENS DC ERRATA	A33	CARICO ASIMMETR
A6	BATTERIA IN TEST	A34	RICHIESTA SERV
A7	BCB APERTO	A35	BATT DIESEL MODE
A8	BATTERIA IN SCAR	A36	SPEGNIM VELOCE
A9	FINE AUT BATTERIA	A37	ALTA TEMP RADD
A10	ANOMALIA BATT	A38	INV -- > CARICO
A11	CORTO CIRCUITO	A39	ERRORE LOOP INV
A12	STOP TIMEOUT CC	A40	ANOMALIA SSI
A13	INV FUORI TOL	A41	ERR LOOP TEN RAD
A14	ER SENSO CIC BYP	A42	GUASTO FUSIB ING
A15	BYPASS NON DISP	A43	ERR LOOP COR RAD
A16	BYP -- > CARICO	A44	DESATURAZIONE
A17	RITRASF BLOC	A45	ALTA TEMP SSW
A18	MBCB CHIUSO	A46	PERDITA RIDOND
A19	OCB APERTO	A47	ERR INVIO PARAM
A20	SOVRACCARICO	A48	ERR RIC PARAM EE
A21	IMMAGINE TERMICA	A49	DISCOR TEST MODE
A22	BYPASS SWITCH	A50	SSW BLOCCATO
A23	EPO CHIUSO	A51	TEMPERATURA BATT
A24	ALTA TEMP INV/ DC F	A53	ER COMP FIRMWARE
A25	INVERTER SPENTO	A54	ERRORE CAN
A26	PERDITA COMUNIC	A55	CAVO PAR DISC
A27	ERRORE EEPROM	A56	TERNA SBILANCIATA
A28	GUASTO CRITICO	A63	SEQ. AVVIO BLOCC

STATI

- S1** BOOSTER OK
- S2** BATTERIA OK
- S3** INVERTER OK
- S4** INV -- > CARICO
- S5** INV BYPASS SINCRO
- S6** BYPASS OK
- S7** BYPASS -- > CARICO
- S8** CARICA BOOST
- S9** INV MASTER SINCRO



Modalità visualizzazione e registrazione allarmi

- Quando si entra nel menù ALLARMI – STATI gli stati vengono visualizzati sempre in ordine crescente.
- Gli allarmi vengono mostrati quando si presentano e devono essere tacitati con il buzzer.
- Gli allarmi restano visibili finché sono presenti e vengono registrati automaticamente nello storico eventi, con data e ora.



Descrizione degli allarmi e degli stati

Per una descrizione più approfondita degli allarmi e degli stati vedere la sezione del presente manuale “Guasti e allarmi”.

6 IMPOSTAZIONI E OPERAZIONI AVANZATE

L'impostazione di alcuni parametri operativi dell'UPS è possibile dal menu SPECIALE, che è strutturato come segue.



Figura 11 – Struttura menu SPECIALE

Sotto-menu	Dati programmabili
RESET	Reset di alcune condizioni di blocco
SETTAGGIO OROLOGIO	Data e ora di sistema
SELEZIONE LINGUA	Impostazione lingua display
TEST UPS	Effettua un test di commutazione
CONFIGURAZ. BATTERIA	Impostazione parametri di batteria
TEST BATTERIA	Effettua un test della batteria
INSTALL NUOVA BATT	Imposta l'autonomia al 100%
RESET STORICO	Reset dello storico eventi
MODBUS	Indirizzo MODBUS del dispositivo
AZZERA CONTAORE	Azzeramento del contaore di funzionamento della macchina

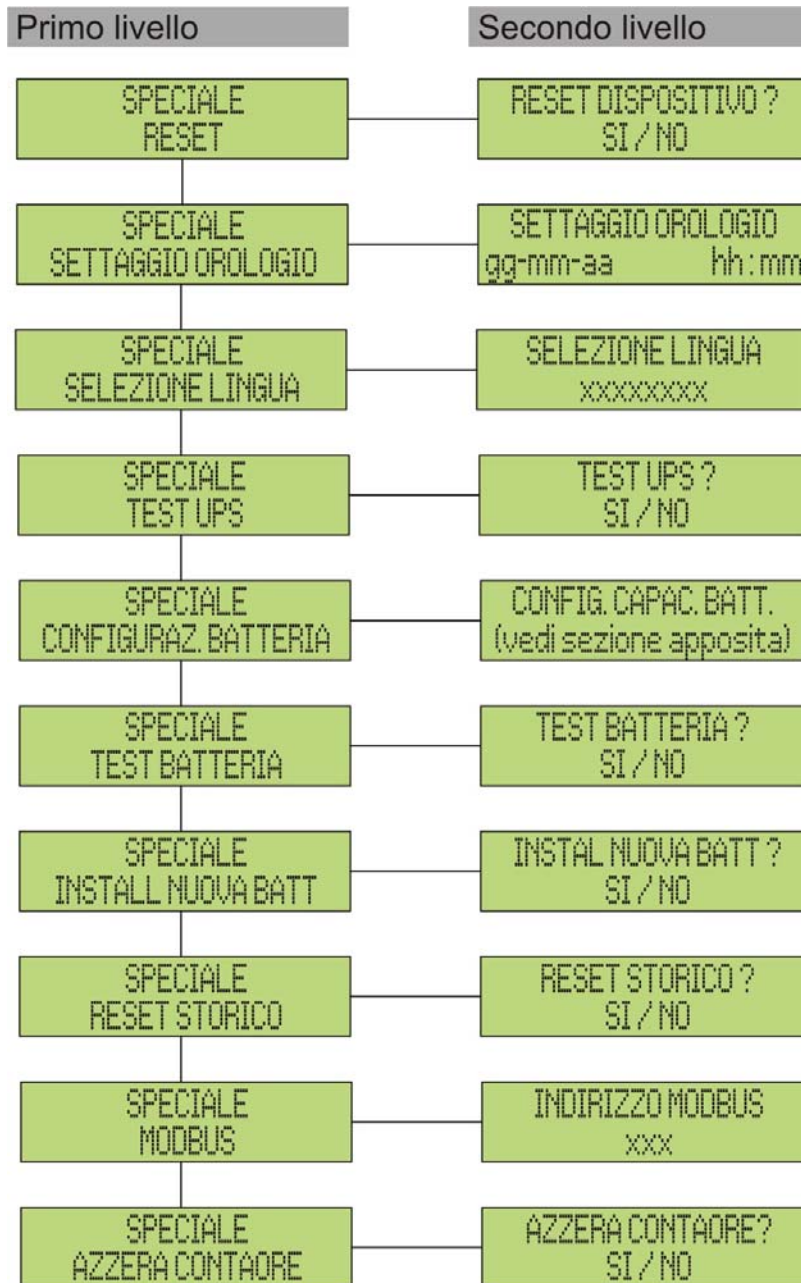

Accesso protetto da password

Il menu IMPOSTAZIONI è protetto da una password impostata in fabbrica per impedire l'accesso a personale non autorizzato.

- Si raccomanda la minima divulgazione della password di accesso.
- Modifiche ai parametri operativi e avvio di operazioni sull'UPS possono essere potenzialmente pericolose per il dispositivo stesso e per le persone.

6.1 IMPOSTAZIONE DI DATA E ORA

La data e l'ora possono essere impostate dal menu OROLOGIO.

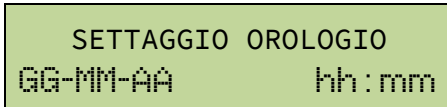

Le singole cifre si modificano con i tasti freccia (▲ / ▼) e si confermano con il tasto ← (ENTER)



Impostare correttamente data e ora correnti

La corretta impostazione della data e dell'ora è fondamentale per la registrazione dello storico eventi.

6.2 IMPOSTAZIONE LINGUA DISPLAY

La tabella che segue mostra i linguaggi impostabili per il display.

Parametro	Range
LINGUA	ITALIANO TEDESCO FRANCESE INGLESE PORTOGHESE SPAGNOLO POLACCO TURCO

La modifica dei parametri si effettua utilizzando i tasti freccia (▲ / ▼) per incrementare le cifre e il tasto ← per confermare l'inserimento.

6.3 INSTALLAZIONE NUOVA BATTERIA

Il menù INSTALLAZIONE NUOVA BATTERIA serve nel caso in cui durante la fase di avvio non viene chiuso l'interruttore di batteria BCB quando richiesto. In tal caso il sistema si avvia considerando la batteria completamente scarica e attivando l'allarme "A10 – ANOMALIA BATT".

Per impostare l'autonomia della batteria al 100% è necessario accedere al menù e premere il tasto ← per confermare.

6.4 CONFIGURAZIONE BATTERIA

Nel caso che l'UPS sia stato collaudato senza che fossero noti i dati caratteristici della batteria di accumulatori il menù CONFIGURAZIONE BATTERIA permette l'impostazione degli stessi. In particolare possono essere impostati.

- Capacità batteria in Amperora (Ah)
- Corrente di ricarica in Ampere (A)
- Autonomia nominale in minuti

Accedere al menù premendo il tasto  (ENTER).

CONFIG. CAPAC. BATT.
0120

Le singole cifre si modificano con i tasti freccia (▲/▼) e si confermano con il tasto  (ENTER)



CONF. CAPACITA' BATT?
SI

Schermata di conferma del parametro impostato



CONFIG COR RICAR BAT
18

Le singole cifre si modificano con i tasti freccia (▲/▼) e si confermano con il tasto  (ENTER)



CONF CORR RICARICA?
SI

Schermata di conferma del parametro impostato



CONFIG AUTONOMIA BAT
0020

Le singole cifre si modificano con i tasti freccia (▲/▼) e si confermano con il tasto  (ENTER)



CONF AUTONOMIA BATT?
SI

Schermata di conferma del parametro impostato



SALVARE CONFIG BATT?
SI

Schermata di conferma della configurazione



CONFIG BATT. SALVATA
PREMERE "ENTER"



Impostare tutti i parametri

Per salvare tutti i parametri è necessario arrivare alla fine della procedura guidata, fino all'ultima schermata mostrata in precedenza.

Se la procedura viene interrotta prima nessuno dei parametri impostati in precedenza verrà salvato.

6.5 IMPOSTAZIONE PARAMETRI MODBUS

All'interno del menu MODBUS possono essere impostati i parametri relativi alla comunicazione tramite supporto RS485.

➤ Indirizzo Modbus

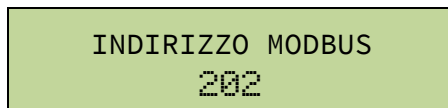

Le singole cifre si modificano con i tasti freccia (▲ / ▼) e si confermano con il tasto ← (ENTER)

Parametro	Standard	Range
INDIRIZZO MODBUS	1	1 247

6.6 TEST DELL'UPS

Il menù UPS TEST permette di effettuare una prova di commutazione dell'inverter. L'inverter viene spento e il carico trasferito all'alimentazione di bypass. L'alimentazione da inverter viene ripristinata automaticamente dopo pochi secondi.

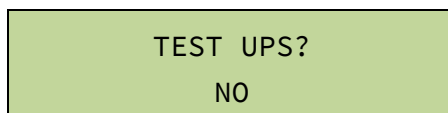

Il valore sulla seconda riga è pronto per essere modificato



Il parametro è modificato, la modifica si conferma premendo il tasto ← (ENTER)



Il sistema effettua il test e si porta alla schermata precedente



Possibile perdita di alimentazione

In caso di mancanza rete durante l'effettuazione del test non è garantito l'intervento immediato dell'inverter.

6.7 TEST DI BATTERIA

Il menù TEST DI BATTERIA permette di effettuare una breve prova di scarica della batteria. Nel caso la batteria non sia efficiente al termine del test viene generato l'allarme "A10 – ANOMALIA BATT".

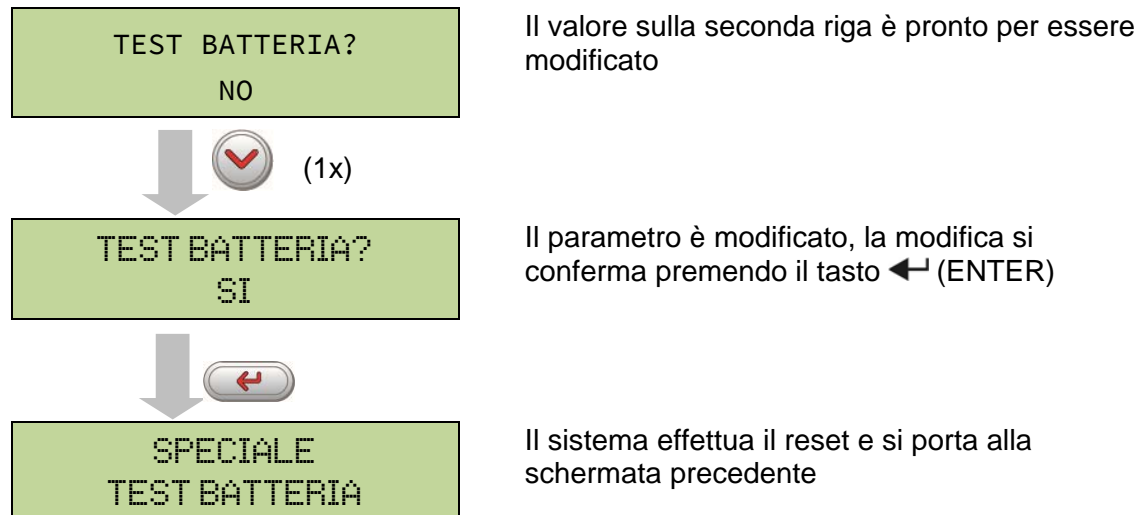

Possibile perdita di alimentazione

Questo test può essere rischioso per la continuità sui carichi se la batteria non è pienamente carica.

6.8 RESET DEL SISTEMA

L'UPS è provvisto di protezioni interne che provvedono al blocco del sistema o di alcune sue sezioni. Tramite il menu RESET è possibile sbloccare l'allarme e ripristinare il funzionamento normale. Nel caso l'anomalia persista l'UPS si riporta nella condizione di blocco precedente.

In alcuni casi il RESET è necessario per ripristinare semplicemente una segnalazione di anomalia, quindi l'UPS continua a funzionare.

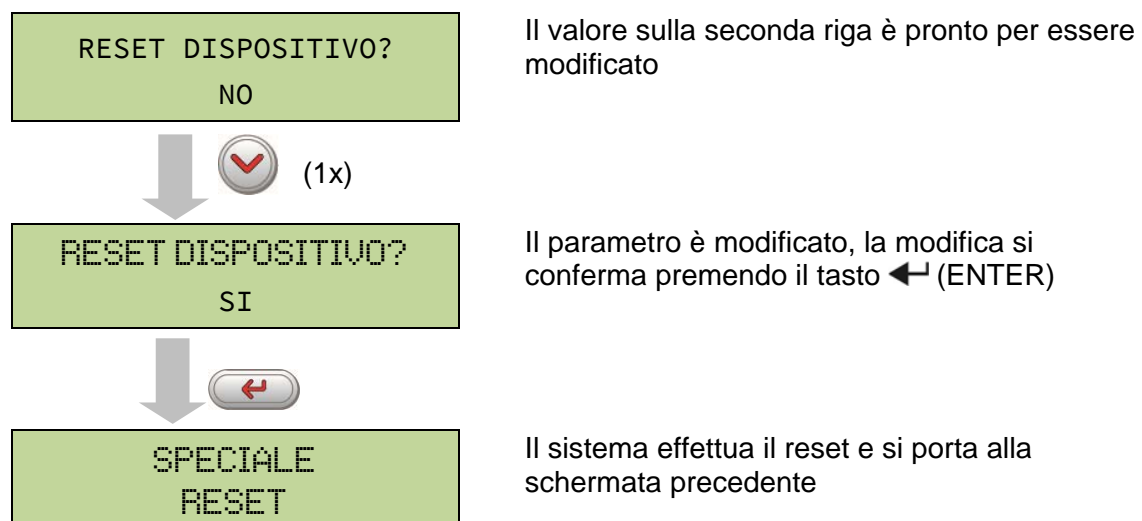

Le condizioni di blocco che impongono un reset manuale sono:

- Blocco ritrasferimento interruttore statico (allarme A17)
- Arresto inverter per intervento del sensore di desaturazione IGBT (allarme A44)
- Arresto inverter per timeout corto-circuito (allarme 12)
- Arresto inverter per intervento protezione immagine termica (allarme 21)
- Arresto inverter per intervento sensore di spegnimento veloce (allarme A36)
- Arresto inverter per errore loop di controllo tensione (allarme A39)
- Arresto booster per errore loop di controllo tensione (allarme A41)
- Arresto booster per errore loop di controllo corrente (allarme A43)
- Blocco interruttore statico (allarme A50)
- Arresto booster per intervento del sensore di simmetria del carico (allarme A33)
- Intervento allarme di avaria batteria (allarme A10)
- Richiesta manutenzione programmata (allarme A29)

Per la descrizione dello stato dell'UPS in ciascuna delle condizioni di blocco elencata in precedenza fare riferimento alla sezione "Guasti e allarmi".

6.9 RESET STORICO ALLARMI

Accedere al menu RESET STORICO.

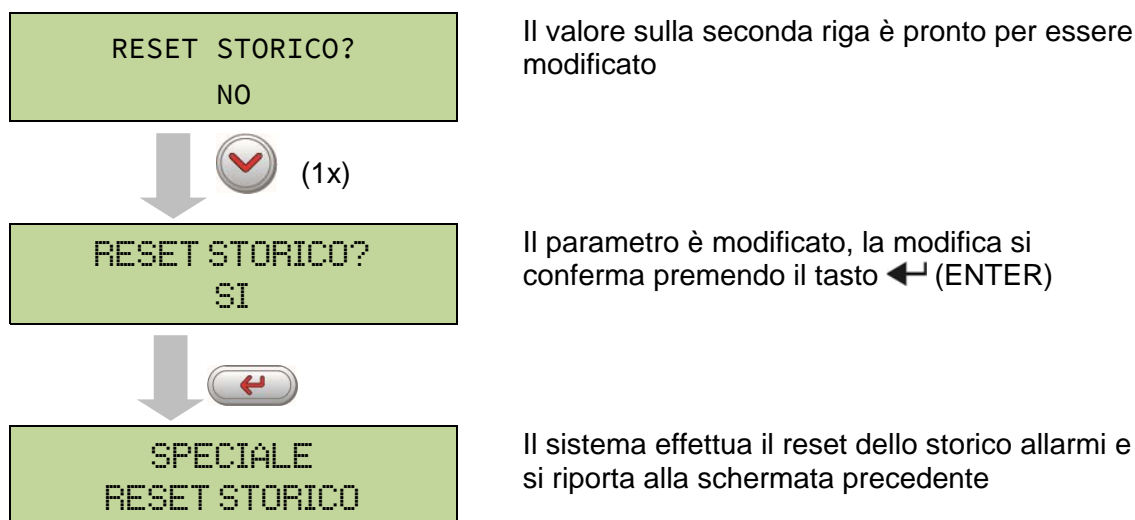

Perdita di dati

Lo storico eventi contiene dati molto importanti per monitorare il comportamento del dispositivo nel tempo. Si consiglia di provvedere al salvataggio dei dati prima di effettuarne la cancellazione.

7 INFORMAZIONI SUL SISTEMA

Il menu INFO fornisce informazioni generali sull'UPS, secondo la struttura mostrata di seguito.



Figura 12 – Struttura menu INFO

Tutti i dati mostrati all'interno delle varie sezioni sono impostati in fabbrica tramite apposito software di interfaccia e non possono essere modificati tranne che da parte di personale autorizzato dal costruttore.

Gli unici parametri modificabili sono le impostazioni MODBUS (vedi menu SPECIALE).

Sotto-menu	Dati visualizzati
NUMERO SERIE	Numero di serie del dispositivo assegnato dal costruttore e da eventuale distributore OEM
TIPO DISPOSITIVO	Tipologia dispositivo, può essere: <ul style="list-style-type: none"> ➤ UPS – ON LINE ➤ CONVERTITORE DI FREQUENZA ➤ UPS – ECO MODE ➤ SINGOLO UPS ➤ PARALLELO
PARALLELO ⁽¹⁾	Dati relativi alla configurazione parallelo
MODBUS	Indirizzo MODBUS del dispositivo
VERSIONE FIRMWARE	Versioni firmware installate a bordo del sistema
SERVICE	Stringa di testo scorrevole con informazioni relative all'assistenza tecnica
CONTAORE	Dati relativi al numero di ore di funzionamento della macchina

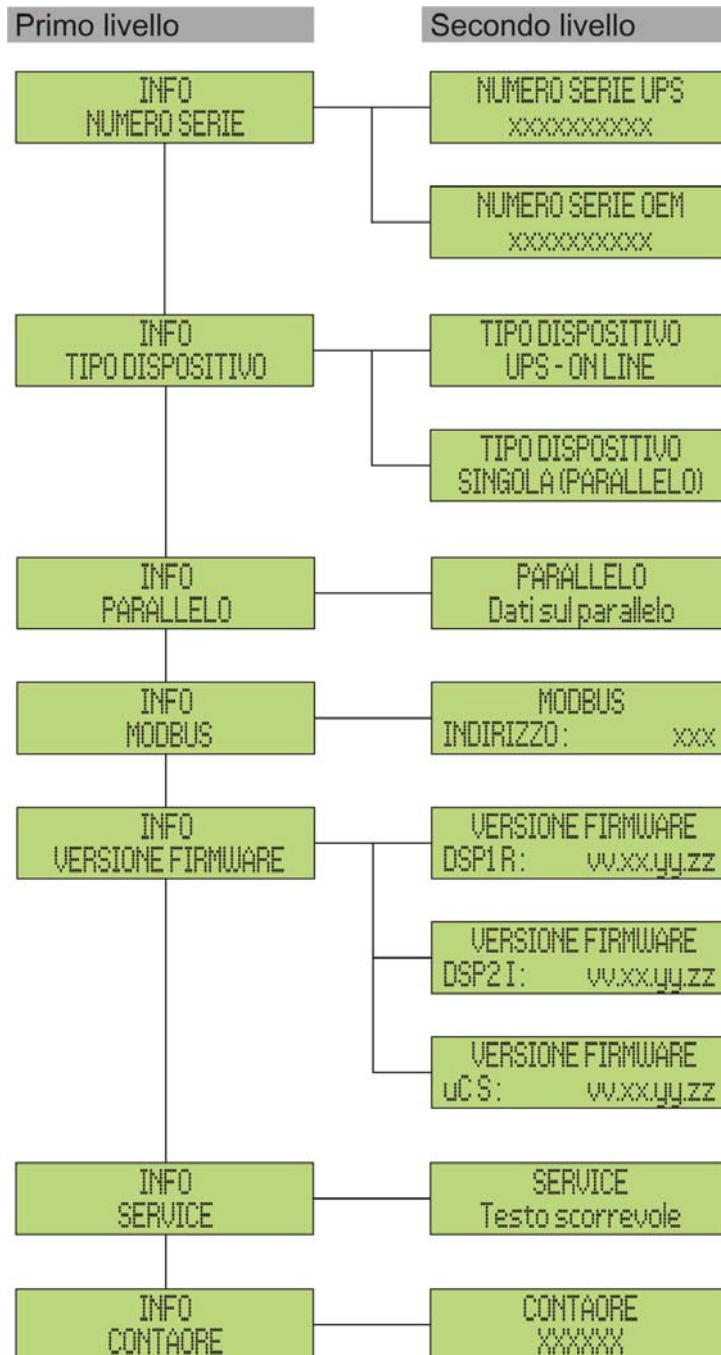
⁽¹⁾ Il menù è attivo solamente se l'UPS fa parte di un sistema Parallelo, oppure Load Sync

7.1 INFORMAZIONI SUL FUNZIONAMENTO IN PARALLELO

Il menù PARALLELO è attivo solamente se l'UPS fa parte di un sistema parallelo oppure load-sync.

7.1.1 Posizione dell'UPS

PARALLELO
2 / 6

Il primo numero sulla seconda riga identifica la *posizione* di quel particolare UPS nel sistema di parallelo; il secondo numero rappresenta il numero totale di UPS.

7.1.2 Priorità Master / Slave

PARALLELO
MASTER

La stringa sulla seconda riga può avere due valori, "MASTER" oppure "SLAVE". Nel sistema può essere presente un solo UPS *MASTER*, in caso contrario c'è un conflitto sul bus di comunicazione dati.

7.1.3 Controllo bus di comunicazione

```
PARALLELO
1- [ M  2-  3- S  4- S
   ]      S
```

La seconda riga di questo menù dà un'indicazione di massima della comunicazione fra gli UPS che compongono il sistema.

- I numeri rappresentano i singoli UPS.
- Le lettere M e S stanno rispettivamente per MASTER e SLAVE.
- Le parentesi [] intorno ad una lettera indicano che stiamo lavorando su quello specifico UPS.
- Un eventuale punto interrogativo accanto ad un numero indica che quell'UPS non sta comunicando sul bus dati.

Supponiamo di avere la seguente situazione:

- sistema composto da 4 UPS;
- al momento l'UPS MASTER è l'UPS2;
- stiamo verificando la comunicazione dati sull'UPS3;
- l'UPS4 non comunica.

Il menù si presenterà come mostrato di seguito.

```
PARALLELO
1- S  2-  3- [  4- ?
      M  S ]
```

Nel caso che i dispositivi in parallelo siano più di quattro il menù si presenta come segue.

```
PARALLELO
1- S  2-  3- [  ....
      M  S ]
```

I punti indicano la presenza di un ulteriore menù che mostra lo stato degli altri UPS del sistema.

7.1.4 Tipo di parallelo

```
PARALLELO
RIDONDANTE+x
```

La stringa sulla seconda riga può avere due valori, "POTENZA" oppure "RIDONDANTE+x"

- POTENZA significa che il sistema di parallelo è impostato in maniera tale da necessitare della presenza di tutti gli UPS per alimentare il carico.

-
- RIDONDANTE+x significa che il sistema è ridondante e l'indice di ridondanza è indicato dal numero "x". Per esempio, in un sistema composto da 3 UPS, "RIDONDANTE+2" significa che uno solo degli UPS è sufficiente per alimentare il carico.

7.1.5 Statistiche messaggi

La sezione statistiche relative ai messaggi scambiati sui bus di comunicazione si compone di tre diversi menù.

```
STATIST CAN SSW
MSG RX: 32564
100.0%
```

Numero di messaggi ricevuti e percentuale di accuratezza della ricezione, relativamente allo stato degli interruttori statici. I messaggi vengono scambiati fra tutti gli UPS, quindi il numero incrementa su tutti.

```
STATIST CAN INV
SYNC RX: 15849
100.0%
```

Numero di messaggi ricevuti e percentuale di accuratezza della ricezione, relativamente ai segnali di sincronismo. I messaggi vengono inviati dall'UPS MASTER, quindi il numero incrementa solo sugli UPS SLAVE.

```
STATIST CAN INV
MSG RX: 9277
99.9%
```

Numero di messaggi ricevuti e percentuale di accuratezza della ricezione, relativamente agli stati del sistema. I messaggi vengono scambiati fra tutti gli UPS, quindi il numero incrementa su tutti.

7.2 INFORMAZIONI RELATIVE ALL'ASSISTENZA

Il menu SERVICE fornisce informazioni importanti relativamente all'assistenza tecnica sull'UPS.

Le informazioni sono visualizzate tramite una stringa di testo di max. 60 caratteri che scorre sulla seconda riga del display.

Fare comunque riferimento anche agli indirizzi e ai numeri di contatto riportati nel presente manuale.

8 GUASTI E ALLARMI

Come indicato nei capitoli precedenti il sistema è provvisto di una diagnostica di base che permette la visualizzazione immediata delle condizioni di funzionamento.

Il pannello LCD si porta immediatamente sulla schermata degli allarmi e viene attivato il segnalatore acustico (se abilitato). In ogni schermata vengono visualizzati il codice alfanumerico dell'allarme e una breve descrizione dello stesso.

STATO UPS
A15 BYPASS NON DISP

Il display mostra il primo allarme in ordine cronologico



STATO UPS
A30 ALLARME GENERALE

Scorrendo il menu vengono visualizzati gli altri allarmi presenti



STATO UPS
S1 BOOSTER OK

Dopo l'ultimo allarme presente si passa alla visualizzazione degli stati operativi



Pericolo di lesioni a seguito shock elettrico

Prima di effettuare qualsiasi intervento sull'UPS aver cura di rispettare tutte le indicazioni relative alla sicurezza:

- tutti i lavori sull'apparato devono essere svolti da personale qualificato;
- accedere ai componenti interni solo dopo aver disconnesso il dispositivo dalle sorgenti di alimentazione;
- utilizzare sempre i dispositivi di protezione specifici per ciascun tipo di attività;
- seguire scrupolosamente le istruzioni riportate nei manuali;
- in caso di dubbi o impossibilità a risolvere il problema si prega di contattare immediatamente Legrand.

8.1 DEFINIZIONE DEGLI STATI DI FUNZIONAMENTO

Stato	S1	BOOSTER OK
Descrizione	La sezione raddrizzatore funziona regolarmente.	
Condizione operativa	Il raddrizzatore alimenta l'inverter e tiene in carica la batteria.	

Stato	S2	BATTERIA OK
Descrizione	La batteria è connessa all'UPS.	
Condizione operativa	La batteria viene tenuta in carica dal raddrizzatore ed è pronta ad alimentare l'inverter.	

Stato	S3	INVERTER OK
Descrizione	La tensione e la frequenza dell'inverter sono nel range ammesso.	
Condizione operativa	L'inverter è pronto per erogare alimentare il carico.	

Stato	S4	INV --> CARICO
Descrizione	L'inverter alimenta il carico.	
Condizione operativa	Il carico è alimentato attraverso l'interruttore statico di inverter.	

Stato	S5	INV BYPASS SINCR0
Descrizione	L'inverter è sincronizzato con il bypass.	
Condizione operativa	Il sincronismo fra inverter e bypass è agganciato e l'interruttore statico può effettuare commutazioni fra le due sorgenti.	

Stato	S6	BYPASS OK
Descrizione	La tensione e la frequenza del bypass sono nel range ammesso.	
Condizione operativa	La rete di bypass è disponibile alla commutazione in caso di guasto inverter.	

Stato	S7	BYPASS --> CARICO
Descrizione	Carico alimentato dalla rete di bypass.	
Condizione operativa	Il carico è alimentato da bypass attraverso l'interruttore statico, si attende il riavvio dell'inverter.	

Stato	S8	CARICA BOOST
Descrizione	La batteria è in carica <i>BOOST</i> .	
Condizione operativa	Il raddrizzatore sta caricando la batteria con tensione maggiore. Il ritorno alle condizioni di carica <i>TAMPONE</i> è automatico.	

Stato	S9	INV MASTER SINCRO
Descrizione	L'inverter è sincronizzato con l'UPS MASTER.	
Condizione operativa	Questo stato è presente solo sugli UPS SLAVE e indica che l'inverter è sincronizzato con il segnale inviato dall'UPS MASTER.	

8.2 CONTROLLO DEI GUASTI

Allarme	A1	MANCANZA RETE
Descrizione	La tensione o la frequenza della rete di ingresso sono fuori dal range di tolleranza.	
Possibili cause	<ul style="list-style-type: none">➤ Instabilità o mancanza della rete.➤ Errato senso ciclico delle fasi.	
Soluzioni	<ol style="list-style-type: none">1. Controllare i collegamenti di connessione alla rete.2. Verificare la stabilità della tensione di rete.3. Se l'allarme persiste contattare il servizio di Assistenza Tecnica.	

Allarme	A2	ER SENSO CICL ING
Descrizione	Il senso ciclico delle fasi della rete di ingresso al raddrizzatore è errato.	
Possibili cause	<ul style="list-style-type: none">➤ Errato collegamento dei cavi di potenza.	
Soluzioni	<ol style="list-style-type: none">1. Verificare il senso ciclico delle fasi.2. Se l'allarme persiste contattare il servizio di Assistenza Tecnica.	

Allarme	A3	RADD SPENTO
Descrizione	Il raddrizzatore è stato momentaneamente arrestato e l'inverter viene alimentato dalla batteria.	
Possibili cause	<ul style="list-style-type: none">➤ Instabilità della tensione o della frequenza della rete AC.➤ Possibile guasto del circuito di controllo del raddrizzatore.	
Soluzioni	<ol style="list-style-type: none">1. Verificare i parametri della tensione della rete AC.2. Riavviare il dispositivo.3. Se l'allarme persiste contattare il servizio di Assistenza Tecnica.	

Allarme	A4	ANOMALIA RADD
Descrizione	Il raddrizzatore è stato arrestato per anomalia interna.	
Possibili cause	<ul style="list-style-type: none">➤ Possibile guasto del circuito di controllo del raddrizzatore.	
Soluzioni	<ol style="list-style-type: none">1. Verificare quali allarmi sono presenti e seguire le procedure indicate.2. Riavviare il dispositivo.3. Se l'allarme persiste contattare il servizio di Assistenza Tecnica.	

Allarme	A5	TENS DC ERRATA
Descrizione	La tensione DC misurata è fuori dai limiti di tolleranza.	
Possibili cause	<ul style="list-style-type: none"> ➤ In mancanza rete la batteria ha raggiunto la tensione di scarica. ➤ Guasto del circuito di misura. 	
Soluzioni	<ol style="list-style-type: none"> 1. Verificare il valore effettivo della tensione DC misurata. 2. In caso di mancanza rete attendere che la tensione AC venga ripristinata. 3. Verificare quali allarmi sono presenti e seguire le procedure indicate. 4. Riavviare il dispositivo. 5. Se l'allarme persiste contattare il servizio di Assistenza Tecnica. 	

Allarme	A6	BATTERIA IN TEST
Descrizione	La tensione del raddrizzatore viene ridotta per avviare una breve scarica controllata della batteria.	
Possibili cause	<ul style="list-style-type: none"> ➤ E' stato avviato un test di batteria, automaticamente (se impostato) oppure manualmente dall'operatore. 	
Soluzioni	<ol style="list-style-type: none"> 1. Attendere la fine del test e verificare eventuali anomalie della batteria. 	

Allarme	A7	BCB APERTO
Descrizione	Il sezionatore di batteria è aperto.	
Possibili cause	<ul style="list-style-type: none"> ➤ Sezionatore di batteria aperto. 	
Soluzioni	<ol style="list-style-type: none"> 1. Verificare lo stato del sezionatore di batteria. 2. Verificare la funzionalità del contatto ausiliario del sezionatore. 3. Verificare il collegamento tra il contatto ausiliario del sezionatore e i morsetti ausiliari dell'UPS (se previsti). 4. Se l'allarme persiste contattare il servizio di Assistenza Tecnica. 	

Allarme	A8	BATTERIA IN SCAR
Descrizione	La batteria è in scarica.	
Possibili cause	<ul style="list-style-type: none"> ➤ Batteria in scarica a seguito mancanza rete. ➤ Guasto del raddrizzatore. 	
Soluzioni	<ol style="list-style-type: none"> 1. Verificare quali allarmi sono presenti e seguire le procedure indicate. 2. Se l'allarme persiste contattare il servizio di Assistenza Tecnica. 	

Allarme	A9	FINE AUT BATTERIA
Descrizione	La batteria ha raggiunto il livello di scarica di pre-allarme.	
Possibili cause	<ul style="list-style-type: none">➤ Batteria in scarica a seguito mancanza rete.➤ Guasto del raddrizzatore.	
Soluzioni	<ol style="list-style-type: none">1. Verificare quali allarmi sono presenti e seguire le procedure indicate.2. Se l'allarme persiste contattare il servizio di Assistenza Tecnica.	

Allarme	A10	ANOMALIA BATT
Descrizione	Anomalia a seguito di test di batteria.	
Possibili cause	<ul style="list-style-type: none">➤ Anomalia batteria.	
Soluzioni	<ol style="list-style-type: none">1. Verificare la batteria.2. Resetare il sistema.3. Se l'allarme persiste contattare il servizio di Assistenza Tecnica.	

Allarme	A11	CORTO CIRCUITO
Descrizione	Il sensore di corrente ha rilevato un corto circuito in uscita.	
Possibili cause	<ul style="list-style-type: none">➤ Problema sui carichi.➤ Guasto del circuito di misura.	
Soluzioni	<ol style="list-style-type: none">1. Verificare i carichi connessi all'uscita dell'UPS.2. Se l'allarme persiste contattare il servizio di Assistenza Tecnica.	

Allarme	A12	STOP TIMEOUT CC
Descrizione	Arresto inverter per corto circuito prolungato in assenza rete oppure per sovracorrente in ingresso al ponte inverter.	
Possibili cause	<ul style="list-style-type: none">➤ Corto circuito sui carichi in assenza rete.➤ Guasto del ponte inverter.➤ Picco temporaneo di corrente.	
Soluzioni	<ol style="list-style-type: none">1. Resetare il sistema.2. Se l'allarme persiste contattare il servizio di Assistenza Tecnica.	

Allarme	A13 INV FUORI TOL
Descrizione	La tensione o la frequenza dell'inverter sono fuori dal range di tolleranza.
Possibili cause	<ul style="list-style-type: none">➤ Spegnimento inverter per allarme.➤ Guasto inverter.
Soluzioni	<ol style="list-style-type: none">1. Verificare quali allarmi sono presenti e seguire le procedure indicate.2. Se l'allarme persiste contattare il servizio di Assistenza Tecnica.

Allarme	A14 ER SENSO CIC BYP
Descrizione	Il senso ciclico delle fasi della rete di bypass è errato.
Possibili cause	<ul style="list-style-type: none">➤ Errato collegamento dei cavi di potenza.
Soluzioni	<ol style="list-style-type: none">1. Verificare il senso ciclico delle fasi.2. Se l'allarme persiste contattare il servizio di Assistenza Tecnica.

Allarme	A15 BYPASS NON DISP
Descrizione	La tensione o la frequenza della rete di bypass sono fuori dal range di tolleranza.
Possibili cause	<ul style="list-style-type: none">➤ Instabilità o mancanza della rete di bypass.➤ Errato senso ciclico delle fasi.
Soluzioni	<ol style="list-style-type: none">1. Controllare i collegamenti di connessione alla rete.2. Verificare la stabilità della tensione di rete.3. Se l'allarme persiste contattare il servizio di Assistenza Tecnica.

Allarme	A16 BYP --> CARICO
Descrizione	Il carico è alimentato dalla rete di bypass.
Possibili cause	<ul style="list-style-type: none">➤ Trasferimento momentaneo per guasto inverter.
Soluzioni	<ol style="list-style-type: none">1. Verificare lo stato dell'inverter e controllare eventuali altri allarmi presenti.2. Se l'allarme persiste contattare il servizio di Assistenza Tecnica.

Allarme	A17	RITRASFOCCO
Descrizione	Il carico è bloccato sulla rete di bypass	
Possibili cause	<ul style="list-style-type: none">➤ Commutazioni molto frequenti dovute a spunti di carico.➤ Problemi sull'interruttore statico.	
Soluzioni	<ol style="list-style-type: none">1. Resettare il sistema.2. Verificare gli spunti di corrente dei carichi.3. Se l'allarme persiste contattare il servizio di Assistenza Tecnica.	

Allarme	A18	MBCB CHIUSO
Descrizione	Il sezionatore di bypass manuale è chiuso.	
Possibili cause	<ul style="list-style-type: none">➤ Sezionatore di bypass manuale chiuso.	
Soluzioni	<ol style="list-style-type: none">1. Verificare lo stato del sezionatore di bypass manuale.2. Verificare la funzionalità del contatto ausiliario del sezionatore.3. Se l'allarme persiste contattare il servizio di Assistenza Tecnica.	

Allarme	A19	OCB APERTO
Descrizione	Il sezionatore di uscita è aperto.	
Possibili cause	<ul style="list-style-type: none">➤ Sezionatore di uscita aperto.	
Soluzioni	<ol style="list-style-type: none">1. Verificare lo stato del sezionatore di uscita.2. Verificare la funzionalità del contatto ausiliario del sezionatore.3. Se l'allarme persiste contattare il servizio di Assistenza Tecnica.	

Allarme	A20	SOVRACCARICO
Descrizione	Il sensore di corrente ha rilevato un sovraccarico in uscita. Se l'allarme permane si attiverà la protezione di immagine termica (allarme A21).	
Possibili cause	<ul style="list-style-type: none">➤ Sovraccarico in uscita.➤ Guasto del circuito di misura.	
Soluzioni	<ol style="list-style-type: none">1. Verificare i carichi connessi all'uscita dell'UPS.2. Contattare il servizio di Assistenza Tecnica.	

Allarme	A21 IMMAGINE TERMICA
Descrizione	La protezione di immagine termica si è attivata in seguito ad un sovraccarico prolungato dell'inverter. L'inverter viene arrestato per 30 minuti per poi essere riavviato.
Possibili cause	<ul style="list-style-type: none"> ➤ Sovraccarico in uscita. ➤ Guasto del circuito di misura.
Soluzioni	<ol style="list-style-type: none"> 1. Verificare i carichi connessi all'uscita dell'UPS. 2. Nel caso si voglia ripristinare subito l'alimentazione da inverter resettare il sistema. 3. Se l'allarme persiste contattare il servizio di Assistenza Tecnica.

Allarme	A22 BYPASS SWITCH
Descrizione	E' stato manovrato il selettore "Normale/Bypass"
Possibili cause	<ul style="list-style-type: none"> ➤ Manovra per manutenzione.
Soluzioni	<ol style="list-style-type: none"> 1. Verificare la posizione del selettore. 2. Se l'allarme persiste contattare il servizio di Assistenza Tecnica.

Allarme	A23 EPO CHIUSO
Descrizione	Il sistema è bloccato in seguito all'azionamento del pulsante di arresto di emergenza.
Possibili cause	<ul style="list-style-type: none"> ➤ Azionamento del pulsante di arresto di emergenza (locale o remoto).
Soluzioni	<ol style="list-style-type: none"> 1. Sbloccare l'arresto di emergenza e resettare l'allarme. 2. Se l'allarme persiste contattare il servizio di Assistenza Tecnica.

Allarme	A24 ALT TEM INV/DC F
Descrizione	Alta temperatura del dissipatore di calore del ponte inverter o intervento dei fusibili DC di protezione del ponte inverter.
Possibili cause	<ul style="list-style-type: none"> ➤ Guasto dei ventilatori di raffreddamento del dissipatore. ➤ Temperatura dell'ambiente o dell'aria di raffreddamento troppo elevata. ➤ Intervento dei fusibili DC di protezione.
Soluzioni	<ol style="list-style-type: none"> 1. Controllare il funzionamento dei ventilatori. 2. Pulire le griglie di aerazione e gli eventuali filtri aria. 3. Verificare il sistema di condizionamento (se presente). 4. Verificare lo stato dei fusibili DC in ingresso al ponte inverter. 5. Se l'allarme persiste contattare il servizio di Assistenza Tecnica.

Allarme	A25	INVERTER SPENTO
Descrizione	L'inverter è bloccato per anomalia di funzionamento.	
Possibili cause	➤ Varie.	
Soluzioni	1. Resetare il sistema. 2. Se l'allarme persiste contattare il servizio di Assistenza Tecnica.	

Allarme	A26	PERDITA COMUNIC
Descrizione	Errore interno.	
Possibili cause	➤ Problemi di comunicazione del microcontrollore.	
Soluzioni	1. Se l'allarme persiste contattare il servizio di Assistenza Tecnica.	

Allarme	A27	ERRORE EEPROM
Descrizione	Il controllore ha rilevato un errore nei parametri memorizzati in E ² PROM.	
Possibili cause	➤ Inserimento di parametri errati durante la programmazione.	
Soluzioni	1. Contattare il servizio di Assistenza Tecnica.	

Allarme	A28	GUASTO CRITICO
Descrizione	E' presente un allarme che causa l'arresto di una parte dell'UPS (raddrizzatore, inverter, interruttore statico).	
Possibili cause	➤ Guasto del sistema.	
Soluzioni	1. Verificare quali allarmi sono presenti e seguire le procedure indicate. 2. Se l'allarme persiste contattare il servizio di Assistenza Tecnica.	

Allarme	A29	MANUTENZ PROGRAM
Descrizione	E' necessario effettuare un intervento di manutenzione.	
Possibili cause	➤ E' trascorso il tempo limite dall'ultimo intervento.	
Soluzioni	1. Contattare il servizio di Assistenza Tecnica.	

Allarme	A30	ALLARME GENERALE
Descrizione	Allarme cumulativo.	
Possibili cause	➤ E' presente almeno un allarme.	
Soluzioni	1. Verificare quali allarmi sono presenti e seguire le procedure indicate.	

Allarme	A31	MBCB BUS CHIUSO
Descrizione	Il sezionatore di bypass manuale è chiuso.	
Possibili cause	➤ Sezionatore di bypass manuale chiuso.	
Soluzioni	1. Verificare lo stato del sezionatore di bypass manuale. 2. Verificare la funzionalità del contatto ausiliario del sezionatore. 3. Se l'allarme persiste contattare il servizio di Assistenza Tecnica.	

Allarme	A32	EPO BUS
Descrizione	Il sistema è bloccato in seguito all'azionamento del pulsante di arresto di emergenza.	
Possibili cause	➤ Azionamento del pulsante di arresto di emergenza (locale o remoto).	
Soluzioni	1. Sbloccare l'arresto di emergenza e resettare l'allarme. 2. Se l'allarme persiste contattare il servizio di Assistenza Tecnica.	

Allarme	A33	CARICO ASIMMETR
Descrizione	Le tensioni misurate sui condensatori DC (positiva e negativa verso punto centrale) sono diverse.	
Possibili cause	➤ Possibile guasto del circuito di misura. ➤ Possibile anomalia dei condensatori DC.	
Soluzioni	1. Resettare il sistema. 2. Se l'allarme persiste contattare il servizio di Assistenza Tecnica.	

Allarme	A34	RICHIESTA SERV
Descrizione	E' necessario un intervento di verifica dell'UPS.	
Possibili cause	➤ Possibile anomalia dell'UPS.	
Soluzioni	1. Se l'allarme persiste contattare il servizio di Assistenza Tecnica.	

Allarme	A35	BATT DIESEL MODE
Descrizione	L'UPS è alimentato dal generatore diesel.	
Possibili cause	➤ Il contatto ausiliario di attivazione del generatore diesel, connesso all'UPS, è chiuso e impone tale modalità operativa.	
Soluzioni	<ol style="list-style-type: none">1. Attendere l'arresto del generatore diesel appena la tensione di rete viene ripristinata.2. Verificare la connessione del contatto ausiliario di segnalazione avvio del generatore diesel ai morsetti XD1/XD-2.3. Se l'allarme persiste contattare il servizio di Assistenza Tecnica.	

Allarme	A36	SPEGNIM VELOCE
Descrizione	Arresto inverter per intervento del sensore di protezione per variazioni repentine della tensione DC.	
Possibili cause	➤ Anomalia batteria.	
Soluzioni	<ol style="list-style-type: none">1. Verificare la batteria.2. Resetare il sistema.3. Se l'allarme persiste contattare il servizio di Assistenza Tecnica.	

Allarme	A37	ALTA TEMP RADD
Descrizione	Alta temperatura del dissipatore di calore del raddrizzatore.	
Possibili cause	<ul style="list-style-type: none">➤ Guasto dei ventilatori di raffreddamento del dissipatore.➤ Temperatura dell'ambiente o dell'aria di raffreddamento troppo elevata.	
Soluzioni	<ol style="list-style-type: none">1. Controllare il funzionamento dei ventilatori.2. Pulire le griglie di aerazione e gli eventuali filtri aria.3. Verificare il sistema di condizionamento (se presente).4. Se l'allarme persiste contattare il servizio di Assistenza Tecnica.	

Allarme	A38	INV --> CARICO
Descrizione	Il carico è alimentato dall'inverter. Allarme attivo per UPS in modalità "ECO", dove l'alimentazione privilegiata è dalla rete di bypass.	
Possibili cause	➤ Trasferimento momentaneo per mancanza rete di bypass.	
Soluzioni	<ol style="list-style-type: none">1. Verificare lo stato della rete di bypass e controllare eventuali altri allarmi presenti.2. Se l'allarme persiste contattare il servizio di Assistenza Tecnica.	

Allarme	A39 ERRORE LOOP INV
Descrizione	Il controllo non è in grado di regolare accuratamente la tensione di inverter.
Possibili cause	<ul style="list-style-type: none"> ➤ Guasto del sistema di regolazione.
Soluzioni	<ol style="list-style-type: none"> 1. Resetare il sistema. 2. Se l'allarme persiste contattare il servizio di Assistenza Tecnica.

Allarme	A40 ANOMALIA SSI
Descrizione	Il sistema ha rilevato un'anomalia dell'interruttore statico.
Possibili cause	<ul style="list-style-type: none"> ➤ Possibili problemi sui carichi. ➤ Anomalia dell'interruttore statico.
Soluzioni	<ol style="list-style-type: none"> 1. Verificare l'assorbimento in dei carichi e l'eventuale presenza di componenti continue sulla corrente AC. 2. Se l'allarme persiste contattare il servizio di Assistenza Tecnica.

Allarme	A41 ERR LOOP TEN RAD
Descrizione	Il controllo non è in grado di regolare accuratamente la tensione di uscita raddrizzatore.
Possibili cause	<ul style="list-style-type: none"> ➤ Guasto del sistema di regolazione.
Soluzioni	<ol style="list-style-type: none"> 1. Resetare il sistema. 2. Se l'allarme persiste contattare il servizio di Assistenza Tecnica.

Allarme	A42 GUASTO FUSIB ING
Descrizione	Guasto dei fusibili di protezione AC ingresso raddrizzatore.
Possibili cause	<ul style="list-style-type: none"> ➤ Sovracorrente in ingresso.
Soluzioni	<ol style="list-style-type: none"> 1. Controllare i fusibili verificando lo stato del segnalatore di fusione. 2. Sostituire gli eventuali fusibili guasti. 3. Riavviare il sistema. 4. Se l'allarme persiste contattare il servizio di Assistenza Tecnica.

Allarme	A43	ERR LOOP COR RAD
Descrizione	Il controllo non è in grado di regolare accuratamente la corrente di uscita raddrizzatore.	
Possibili cause	➤ Guasto del sistema di regolazione.	
Soluzioni	1. Resettare il sistema. 2. Se l'allarme persiste contattare il servizio di Assistenza Tecnica.	

Allarme	A44	DESATURAZIONE
Descrizione	L'inverter è bloccato in seguito all'intervento del sensore di desaturazione dei driver IGBT.	
Possibili cause	➤ Anomalia del ponte inverter.	
Soluzioni	1. Resettare il sistema. 2. Se l'allarme persiste contattare il servizio di Assistenza Tecnica.	

Allarme	A45	ALTA TEMP SSW
Descrizione	Alta temperatura del dissipatore di calore dell'interruttore statico.	
Possibili cause	➤ Guasto dei ventilatori di raffreddamento del dissipatore. ➤ Temperatura dell'ambiente o dell'aria di raffreddamento troppo elevata.	
Soluzioni	1. Controllare il funzionamento dei ventilatori. 2. Pulire le griglie di aerazione e gli eventuali filtri aria. 3. Verificare il sistema di condizionamento (se presente). 4. Se l'allarme persiste contattare il servizio di Assistenza Tecnica.	

Allarme	A46	PERDITA RIDOND
Descrizione	Allarme attivo solo su sistemi PARALLELO. La continuità non è garantita in caso di anomalia di uno degli UPS.	
Possibili cause	➤ Il carico totale è superiore al valore massimo atteso. ➤ Possibile guasto del circuito di misura.	
Soluzioni	1. Verificare il carico alimentato dal sistema. 2. Se l'allarme persiste contattare il servizio di Assistenza Tecnica.	

Allarme	A47	ERR INVIO PARAM
Descrizione	Errore interno (ERRORE INVIO PARAMETRI EEPROM).	
Possibili cause	➤ Problemi di comunicazione del microcontrollore.	
Soluzioni	1. Contattare il servizio di Assistenza Tecnica.	

Allarme	A48	ERR RIC PARAM EE
Descrizione	Errore interno (MANCATA RICEZIONE PARAMETRI EEPROM).	
Possibili cause	➤ Problemi di comunicazione del microcontrollore.	
Soluzioni	1. Contattare il servizio di Assistenza Tecnica.	

Allarme	A49	DISCOR TEST MODE
Descrizione	Errore interno.	
Possibili cause	➤ Problemi di comunicazione del microcontrollore.	
Soluzioni	1. Contattare il servizio di Assistenza Tecnica.	

Allarme	A50	SSW BLOCCATO
Descrizione	L'interruttore statico è bloccato, il carico non è più alimentato.	
Possibili cause	<ul style="list-style-type: none"> ➤ Anomalia sui carichi. ➤ Possibile guasto dell'UPS. 	
Soluzioni	<ol style="list-style-type: none"> 1. Verificare eventuali anomalie sui carichi. 2. Resetare il sistema. 3. Se l'allarme persiste contattare il servizio di Assistenza Tecnica. 	

Allarme	A51	TEMPERATURA BATT
Descrizione	La temperatura della batteria è fuori dai limiti di tolleranza. Allarme attivo solo se è installata e abilitata la sonda di temperatura sulla batteria.	
Possibili cause	<ul style="list-style-type: none"> ➤ Temperatura anomala all'interno dell'armadio batterie. ➤ Possibile guasto del circuito di misura. 	
Soluzioni	<ol style="list-style-type: none"> 1. Verificare la temperatura sulle batterie ed eventualmente rimuovere la causa di allarme. 2. Se l'allarme persiste contattare il servizio di Assistenza Tecnica. 	

Allarme	A53	ER COMP FIRMWARE
Descrizione	Il controllore ha rilevato un'incompatibilità dei software di controllo.	
Possibili cause	➤ Aggiornamento software non eseguito correttamente.	
Soluzioni	1. Contattare il servizio di Assistenza Tecnica.	

Allarme	A54	ERRORE CAN
Descrizione	Errore interno.	
Possibili cause	➤ Problemi di comunicazione del microcontrollore.	
Soluzioni	1. Contattare il servizio di Assistenza Tecnica.	

Allarme	A55	CAVO PAR DISC
Descrizione	Mancata comunicazione del cavo parallelo.	
Possibili cause	➤ Cavo di parallelo disconnesso o danneggiato.	
Soluzioni	1. Controllare la connessione del cavo 2. Contattare il servizio di Assistenza Tecnica.	

Allarme	A56	TERNA SBILANCIATA
Descrizione	Terna d'ingresso raddrizzatore sbilanciata	
Possibili cause	➤ La terna delle tensioni d'ingresso raddrizzatore sono sbilanciate. ➤ Problema sulla scheda di misura	
Soluzioni	1. Controllare la tensione di ingresso. 2. Contattare il servizio di Assistenza Tecnica.	

Allarme	A63	SEQ. AVVIO BLOCC
Descrizione	Durante l'avvio dell'UPS un'anomalia ha impedito il corretto svolgimento della sequenza.	
Possibili cause	➤ Organi di manovra in posizione errata o manovrati in maniera non corretta. ➤ Possibile guasto interno.	
Soluzioni	1. Verificare che la posizione degli organi di manovra (sezionatori, selettori) sia come specificato nelle procedure (vedi sezione "Installazione ed avviamento"). 2. Se l'allarme persiste contattare il servizio di Assistenza Tecnica.	