

# AUTOMATION CONTROL UNITS for supply inversion



**QUICK TO INSTALL,  
PROVIDE OPTIMUM  
CONTINUITY OF SERVICE**

CATALOGUE  
PAGES  
→ INSIDE

THE GLOBAL SPECIALIST IN ELECTRICAL  
AND DIGITAL BUILDING INFRASTRUCTURES

 **legrand**<sup>®</sup>

# A high-performance range for optimum continuity of service



The new range includes 4 types of control unit, depending on the desired service level and the complexity of the installation. The new control units can be used to set the conditions for supply inversion, switching a generator on or off.

For single-phase, two-phase and three-phase systems.

Used to control phase-to-neutral and phase-to-phase voltage. Compatible with DPX<sup>3</sup> MCCBs, DMX<sup>3</sup> air circuit breakers and CTX<sup>3</sup> contactors.

## FOR STANDARD MANAGEMENT OF 2 CIRCUIT BREAKERS

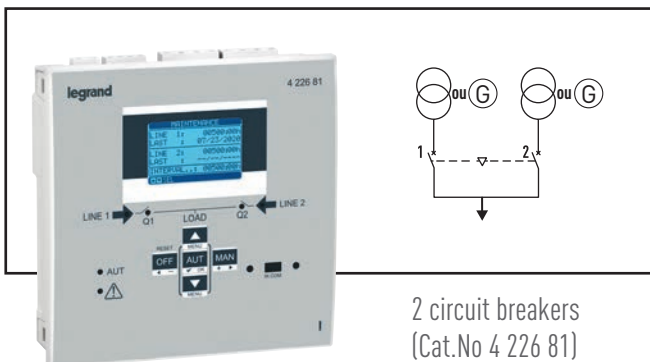

## FOR ADVANCED MANAGEMENT OF 2 CIRCUIT BREAKERS

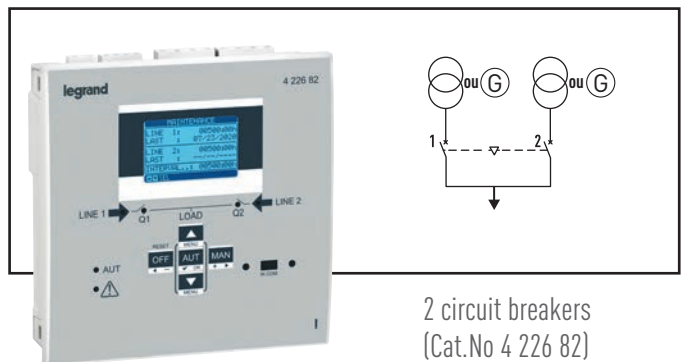

## FOR ADVANCED MANAGEMENT OF 3 CIRCUIT BREAKERS AND 2 POWER SOURCES

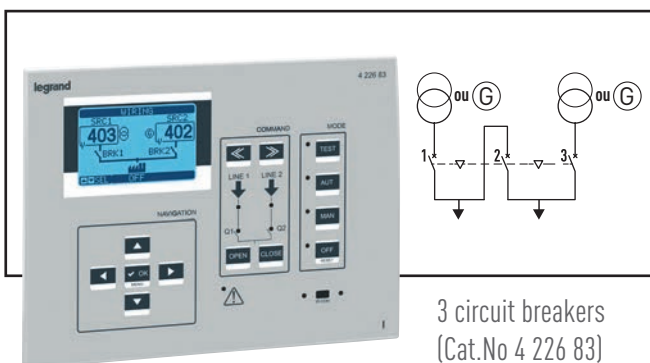

## FOR ADVANCED MANAGEMENT OF 5 CIRCUIT BREAKERS AND 3 POWER SOURCES

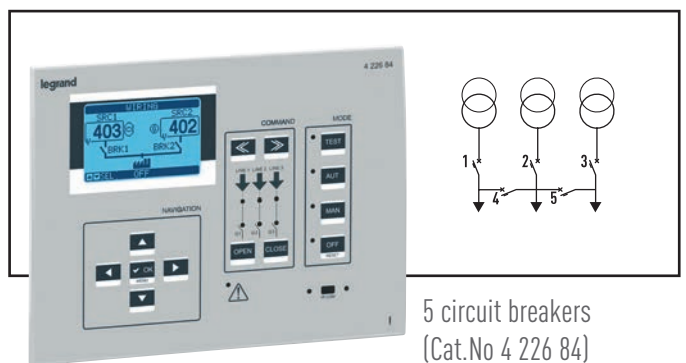

Must be factory configured to fit installation needs  
Please ask for ATS order form.

	4 226 81	4 226 82	4 226 83	4 226 84
<b>POWER SUPPLY</b>	110-240 V=; IP40 (on front panel)	12 – 24 V=; 110 – 240 V~; IP40 (on front panel)	12 – 24 – 48 V=; 110 – 240 V~; IP65 (on front panel)	12 – 24 – 48 V=; 110 – 240 V~; IP65 (on front panel)
<b>CONTROLLED VOLTAGE</b>	(Line 1, Line 2) 2 x 3 phases + N 100 – 480 V~	(Line 1, Line 2) 2 x 3 phases + N 100 – 480 V~	(Line 1, Line 2) 2 x 3 phases + N 100 – 600 V~	(Line 1, Line 2) 3 x 3 phases + N 100 – 600 V~
<b>DISPLAY</b>	Backlit LCD display, 5 languages		Backlit LCD display, 8 languages	
<b>INPUTS</b>	6 programmable digital inputs		8 programmable digital inputs	12 programmable digital inputs
<b>OUTPUTS</b>	7 programmable relay outputs			11 programmable relay outputs
<b>EXPANSION</b>	-	2 modules d'extension pour des entrées/sorties supplémentaires ou des fonctions de communication	3 modules d'extension pour des entrées/sorties supplémentaires	
<b>PORT</b>	Optical port on front panel for USB or Wi-Fi connectors (for configuration from a PC or tablet and smartphone)		- Integrated RS485 communication port - Optical port on front panel for USB or Wi-Fi connectors (for configuration from a PC or tablet and smartphone)	
<b>FUNCTIONS</b>	Line/Line, Line/Generator and Generator/Generator with independent activation and activation delay			All sources configuration available, with independent activation and activation delay
<b>TRANSITION OPTION</b>	Open		Open + Closed-transition load switching with spontaneous or controlled synchronisation of generator sets.	
<b>CONTROL FUNCTIONS ON THE LINES</b>	Min. and max. voltage - Phase cutting - Voltage imbalance - Min. and max. frequency			
<b>CLOCK</b>	-	RTC with working reserve		
<b>STORAGE</b>	-	100 most recent events	250 most recent events	
<b>PROGRAMMING</b>	Direct on front panel or with USB or Wi-Fi communication modules and software or Legrand ACU Configurator app			

## ACCESSORIES

### MODULE FOR DUAL POWER SUPPLY (CAT.No 4 226 86)



→ Used to control and measure the voltages present at its input terminals by identifying the most appropriate voltage for the output. For supplying power to control units for supply invertors, and MCCB motorised controls.

→ The two inputs of the power supply module are independent and isolated; each of them can supply the internal measuring circuit controlled by a microprocessor. It reduces the number of components and improves installation safety.

#### General characteristics:

- Voltage value can be selected using bypass terminals
- Min. and max. voltage trip thresholds
- 2 L+N single-phase inputs
- L+N single-phase output
- L1 priority line
- Can be used with motors supplied with 110 V~ or 230 V~
- LED indicating anomalies, I/O states

### EXPANSION MODULES



Simply clip into place at the back of configurable units (2 or 3 modules depending on the type of unit). Used to increase the number of inputs or outputs or add a communication function.

#### 4 module types with different functions:

- 4 isolated solid state outputs
- 2 isolated digital inputs and 2 isolated relay outputs
- 2 relay outputs: 5 A - 250 V~
- RS485 interface

### USB AND WI-FI CONNECTORS



Make it easy to configure the control unit via a computer or tablet and smartphone (depending on the type chosen) without having to cut off the power to the electrical cabinet. Connect at the front of the device to the optical communication port.

# Devices which perform brilliantly and are easy to use



## BACKLIT SCREEN

Very easy to read, adjustable brightness and contrast. Menu available in 5 or 8 languages depending on unit model

## STYLISH ERGONOMIC DESIGN



## CLEAR MARKING

Clear marking on the front panel for easy identification of the various functions

## TOUCH-SENSITIVE BUTTONS

For programming the various operating parameters directly on the control unit

With its new range of control units, Legrand offers a real turnkey solution to simplify project design, installation and product configuration.

Installation and user manuals, available via the E-Catalogue for each catalogue number, contain a complete set of technical data with wiring diagrams and predefined configurations corresponding to the most commonly found examples of installation (from the simplest to the most complex).

## OPTICAL COMMUNICATION PORT

The optical port on the front can take a USB or a Wi-Fi connection module, which allows communication with a computer, smartphone or a tablet for programming, diagnostics and data downloading, without having to cut off the power to the electrical panel.

## INTUITIVE USER INTERFACE

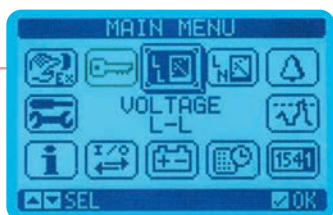

### Simplified access to the various parameters:

- Status
- Voltage and frequency measurement
- Reports
- Trip thresholds
- Alarms



### Counters for maintenance operations:

- Operating hours
- Number of operations by circuit breakers associated with the unit. An alarm trips, as soon as preset thresholds for maintenance operations are reached.

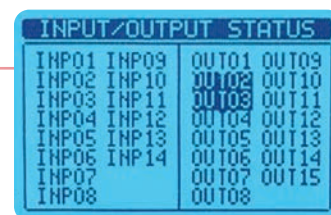

Functions associated with the various inputs and outputs are preconfigured. Other settings are possible, to meet the user's needs as closely as possible.

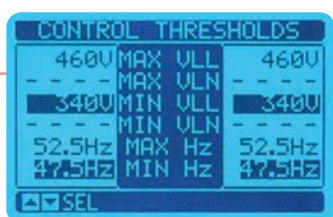

### The settings are grouped into 4 categories:

- Trip thresholds
- Remotely-controllable parameters
- User alarms
- Counters



The event log is used to view the data in order to understand and master how the system works.



Real-time clock with working reserve

## A TURNKEY SOLUTION

With its new range of control units, Legrand offers a real turnkey solution to simplify project design, installation and product configuration.

Installation and user manuals, available via the E-Catalogue for each catalogue number, contain a complete set of technical data with wiring diagrams and predefined configurations corresponding to the most commonly found examples of installation (from the simplest to the most complex).

The automation control units for advanced management of 5 circuit breakers and 3 power sources Cat.No 4 226 84 has a certain number of parameters that must be factory configured in order to perfectly fit the requirements of your project. Please ask for the specific order form including technical support.

## COMPACT SIZE

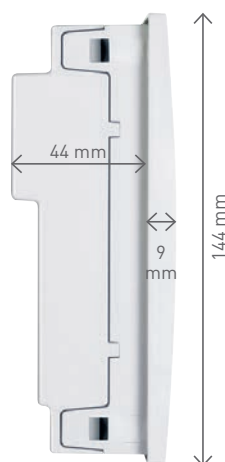

The shallow depth of the configurable controllers makes them exceptionally easy to install, even in slim electrical panels.

## EASY TO INSTALL



The fixing system using metal screws ensures they will stay in place for a long time.



# **Simplified configuration** on PC, tablet or smartphone saves a significant **amount of time**



Configurable models are fitted with an optical port designed to take communication modules. These modules can be used to configure the control units via a PC, tablet or smartphone, on which the software or Legrand app has already been installed.



## USB MODULE

Cat.No 4 226 87 is supplied with a USB cable which can be used to connect the control unit to a computer without having to cut off the power to the electrical cabinet, to program the unit, launch diagnostics, download all the back-up parameters, and update the firmware.



## WI-FI MODULE

Cat.No 4 226 88 can be used to program the unit, launch diagnostics, download all the back-up parameters, or replicate all the data (parameters, counters, log) via a PC, tablet or smartphone, without using a cable. The replication function is useful for transferring all the data from one unit to another or for reverting to a previous configuration (on the same control unit)



## LEGRAND SOFTWARE

Configuration software available for download via the E-Catalogue and the Legrand ACU Configurator app (available from Google Play and Apple Store) in order to:

- Display the values measured by the control unit and check parameter setting
- Control certain control unit functions such as counter reset, activation/deactivation of programmable outputs
- Configure the unit and make a copy in the form of a back-up file
- View current alarms
- Consult the event log and save a copy
- Manage different access password levels
- Manage embedded PLC features (through SW, for the control units Cat.Nos 4 226 83/84)

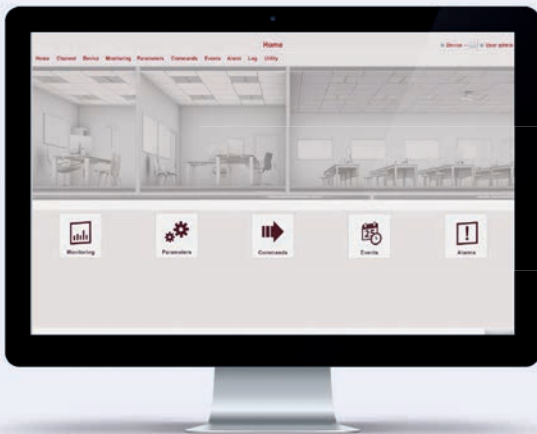

Fast access to the various software functions using pictograms or via the toolbar.

Display of various parameters, grouped in a number of categories (input, output, trip thresholds, alarms, etc)

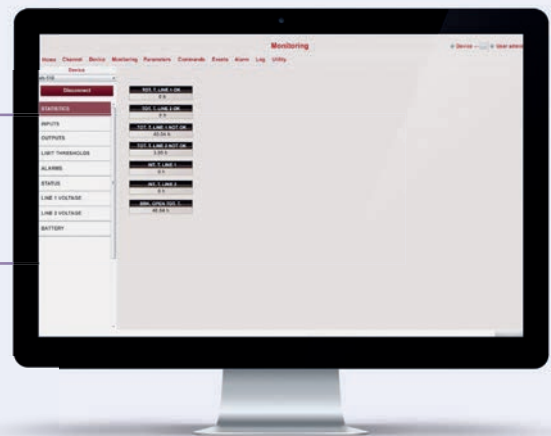

Configuration of the unit and creation of back-up files

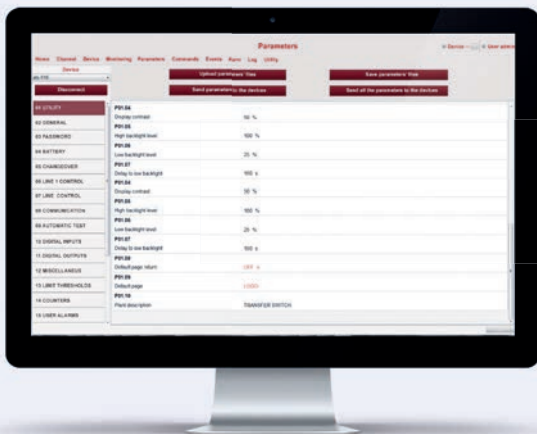



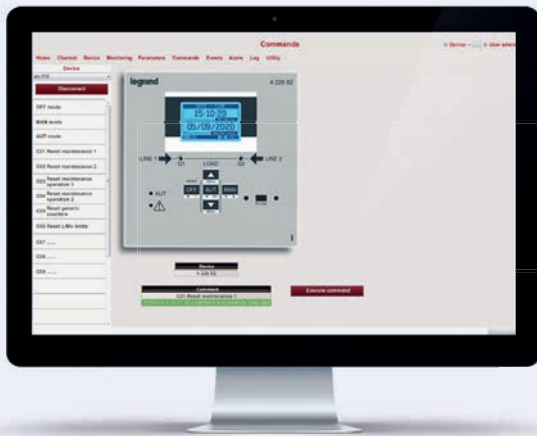

Choice of operating mode (manual/automatic/OFF) and reset

Event log with option to export in TXT or XLS format

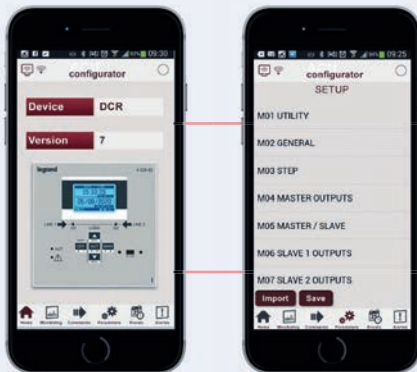
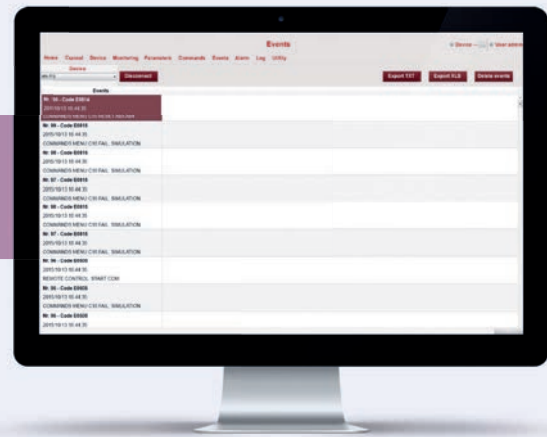

The application is also available on your mobile device or smartphone

# Automatic transfer switch control units



4 226 81



4 226 82 + 4 226 88



4 226 83



4 226 84



4 226 86



4 226 89

Technical characteristics and configuration software  
see e-catalogue

They can control transfer switching between sources, manage generator start/stop, control single phase, two-phase and three-phase networks, control phase-phase and phase-neutral voltages  
For DPX<sup>3</sup> circuit breakers and DMX<sup>3</sup> circuit breakers and CTX<sup>3</sup> contactors

Pack	Cat.Nos	Automatic transfer switch control units	Pack	Cat.Nos	Dual power supply selector	
1	4 226 81 <sup>1</sup>	<b>For standard management of 2 circuit breakers</b> 6 programmable digital inputs and 7 programmable relay outputs LCD display IR communication port on the front panel for connection of USB or WiFi modules Cat.Nos 4 226 87/88 Can be configured with the help of front panel touch keys or of the Legrand dedicated software Power supply: 110-240 V~ IP40	1	4 226 86	Dual power supply selector measures and controls two supply voltages at its inputs (single phase, 230 V~) and selects the most adapted voltage for auxiliary circuits supply Equipped with 1 alarm contact, if no supply voltage can be selected within the limits	
1	4 226 82 <sup>1</sup>	<b>For advanced management of 2 circuit breakers</b> 6 programmable digital inputs and 7 programmable relay outputs Can be equipped with maximum 2 plug-in modules between: - extension modules Cat.Nos 4 226 90/91/92 - opto-isolated RS485 communication interface Cat.No 4 226 89 LCD display IR communication port on the front panel for connection of USB or WiFi modules Cat.Nos 4 226 87/88 Can be configured with the help of front panel touch keys or of the Legrand dedicated software Power supply: 12-24 V= ; 110-240 V~ IP40	1	4 226 89	<b>Plug-in modules</b> 4 226 89 Opto-isolated RS485 interface 4 226 90 4 opto-isolated static outputs 4 226 91 2 relay outputs, rated 5 A 250 V~ 4 226 92 2 opto-isolated digital inputs and 2 relay outputs rated 5 A 250 V~	
1	4 226 83 <sup>1</sup>	<b>For advanced management of 3 circuit breakers and 2 power sources</b> 8 programmable digital inputs and 7 programmable relay outputs Can be equipped with maximum 3 plug-in extension modules between Cat.Nos 4 226 90/91/92 Integrated opto-isolated RS485 communication interface LCD display IR communication port on the front panel for connection of USB or WiFi modules Cat.Nos 4 226 87/88 Can be configured with the help of front panel touch keys or of the Legrand dedicated software Power supply: 12-24-48 V= ; 110-240 V~ IP65	1	4 226 92		
1	4 226 84 <sup>1</sup>	<b>For advanced management of 5 circuit breakers and 3 power sources</b> 12 programmable digital inputs and 11 programmable relay outputs Can be equipped with maximum 3 plug-in extension modules between Cat.Nos 4 226 90/91/92 Integrated opto-isolated RS485 communication interface LCD display IR communication port on the front panel for connection of USB or WiFi modules Cat.Nos 4 226 87/88 Can be configured with the help of front panel touch keys or of the Legrand dedicated software Power supply: 12-24-48 V= ; 110-240 V~ IP65 Must be factory configured to fit installation needs Please ask for ATS order form.	1	4 226 87 <sup>1</sup>		<b>Communication accessories</b> These communication devices can be used to connect Alptec 8 and Alptec 3.2/5.2/8.2 power factor controllers (p. 123) and automatic transfer switch controllers to a computer; smartphone or tablet For programming, downloading data, diagnostics and upgrading the firmware <b>USB front connector</b> Computer connection cable with USB connector The computer identifies the connection as a standard USB connection. There is no need to switch off the controller power supply <b>Wi-Fi front connector</b> Wi-Fi connection device compatible with computers, smartphones and tablets There is no need to switch off the controller power supply
			1	4 226 88 <sup>1</sup>		

1: Configuration software available for download via e-catalogue  
ACU Configurator app for smartphone and tablet available on Apple Store and Google Play

# Automation control units for transfer switches

## technical characteristics and dimensions

### Technical characteristics

		Cat.Nos			
		4 226 81	4 226 82	4 226 83	4 226 84
Voltage Inputs	Ue max rated voltage	100-480 V~	100-480 V~	100-600 V~ L-L (346 V~ L-N)	100-600 V~ L-L (346 V~ L-N)
	Measuring range	50-576 V~ (L-L)	50-576 V~ (L-L)	50-720 V~ (L-L)	50-720 V~ (L-L)
	Frequency range	45...65 Hz 360...440 Hz	45...65 Hz 360...440 Hz	45...65 Hz 360...440 Hz	45...65 Hz 360...440 Hz
	Measurement type	True RMS value	True RMS value	True RMS value	True RMS value
	Connection modes	Single phase, two-phase or three-phase system with or without neutral	Single phase, two-phase or three-phase system with or without neutral	Single phase, two-phase or three-phase system with or without neutral	Single phase, two-phase or three-phase system with or without neutral
	Measuring error	± 0.25% f.s. ± 1 digit	± 0.25% f.s. ± 1 digit	± 0.25% f.s. ± 1 digit	± 0.25% f.s. ± 1 digit
Ambient conditions	Operating temperature	-30... +70 °C	-30... +70 °C	-30... +70 °C	-30... +70 °C
	Storage temperature	-30...+80 °C	-30...+80 °C	-30...+80 °C	-30...+80 °C
	Relativity humidity	80 % (IEC/EN 60068-2-78)	80 % (IEC/EN 60068-2-78)	80 % (IEC/EN 60068-2-78)	80 % (IEC/EN 60068-2-78)
	Maximum pollution degree	2	2	2	2
	Overvoltage category	3	3	3	3
	Measurement category	III	III	III	III
	Rated impulse withstand voltage	Uimp 7.3 kV	Uimp 7.3 kV	Uimp 7.3 kV	Uimp 7.3 kV
	Protection index	IP 40	IP 40	IP 65	IP 65
Functionalities	Inputs	6 programmables	6 programmables	8 programmables	12 programmables
	Outputs	7 relay programmables	7 relay programmables	7 relay programmables	11 relay programmables
	Expandibility	No	Yes (2 modules)	Yes (3 modules)	Yes (3 modules)
	ModBus	No	Yes, with expansion module RS485	Yes, embedded RS485	Yes, embedded RS485
	Storage	No	Yes, 100 most recent events	Yes, 250 most recent events	Yes, 250 most recent events
	Programming	USB or WiFi (Direct on front panel or with comm module and Legrand software or App)			

### Dimensions

#### Cat.No 4 226 86

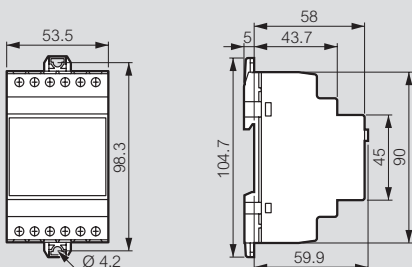

### Dimensions (continued)

#### Cat.Nos 4 226 81/82

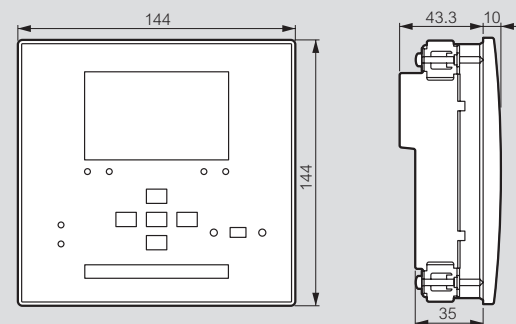

#### Door cut

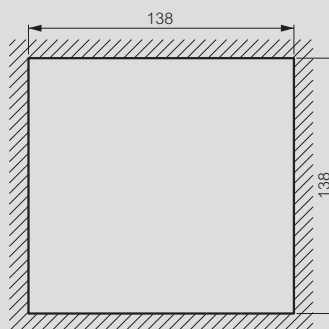

#### Cat.Nos 4 226 83/84

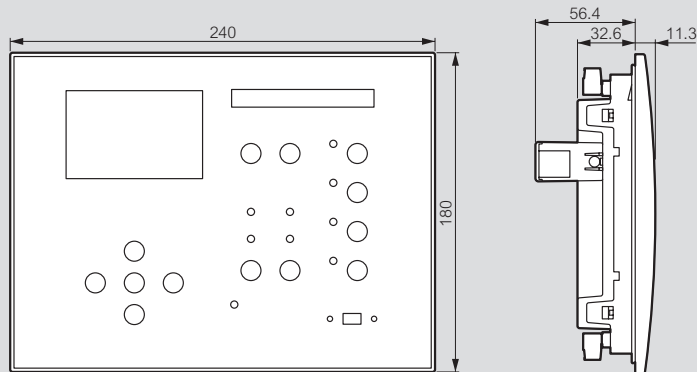



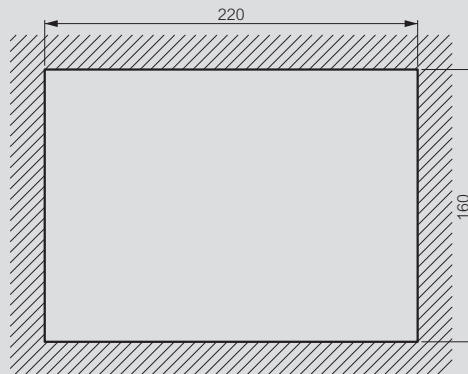

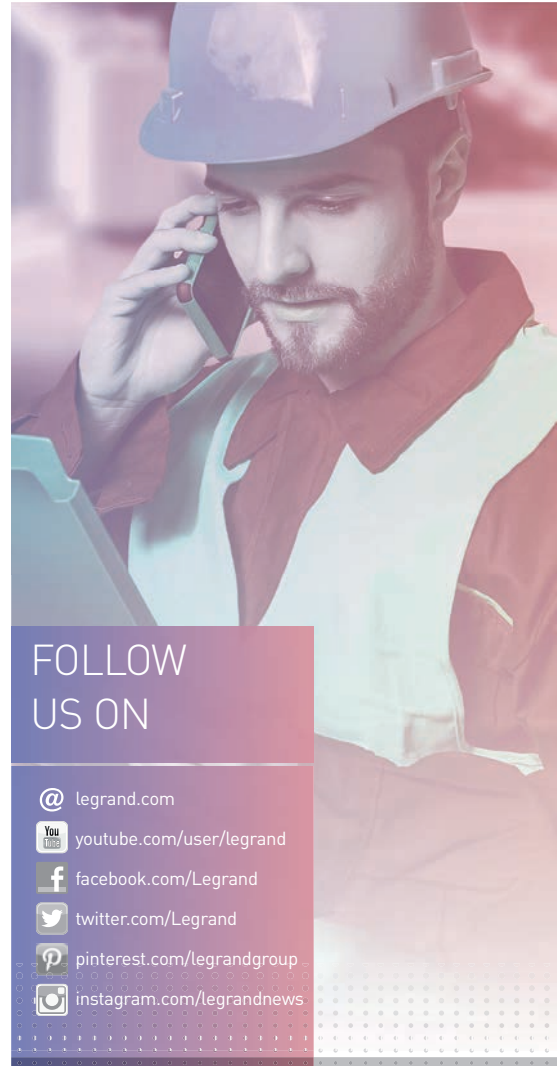
#### Door cut





## FOLLOW US ON

- @ legrand.com
-  youtube.com/user/legrand
-  facebook.com/Legrand
-  twitter.com/Legrand
-  pinterest.com/legrandgroup
-  instagram.com/legrandnews



**Head Office**  
and International Department  
87045 Limoges Cedex - France  
Tel: + 33(0)5 55 06 87 87  
Fax: +33(0)5 55 06 74 55