



# LINKEO DATA CENTER

SERVER CABINETS  
& CORRIDOR SOLUTIONS



# LINKEO DATA CENTER

Server Cabinets & Corridor Solutions

A datacenter includes server cabinets and cables to organize and interconnect all IT equipment (servers, routers, switches, hard disks, etc.). This infrastructure is used by companies to organize, process, store large amounts of data. A datacenter meets very strict technical specifications in order to guarantee its physical and IT security, as well as its operation, which must not experience any interruption or drop in performance. Thermal engineering plays a key role in its design. Such installations generate a lot of heat and need to be cooled to avoid breakdowns.

Discover the new Linkeo Data Center solutions composed of server cabinets and corridor.

- Static heavy duty structure
- Complete in one part number or composable





## GENERAL CHARACTERISTICS

- Dimensions: 42/47U, width 600/800 mm, depth 1000/1200 mm
- 80% perforated front/rear doors for best air circulation
- Simply the raceway for cords are created by fixing cable rings on all profiles in front and rear part of the cabinets
- Easy movable 19" profiles to front/rear
- Multiple brushed cable entries on top and the bottom of the cabinet
- Side panels are lockable & removable in 1 part (depth 1000 mm) or in 2 parts (depth 1200 mm) - for easiest handling
- Ample variety of accessories
- Color: RAL 9005 Black

# LINKEO DATA CENTER

## 19" Free-Standing Server Cabinets

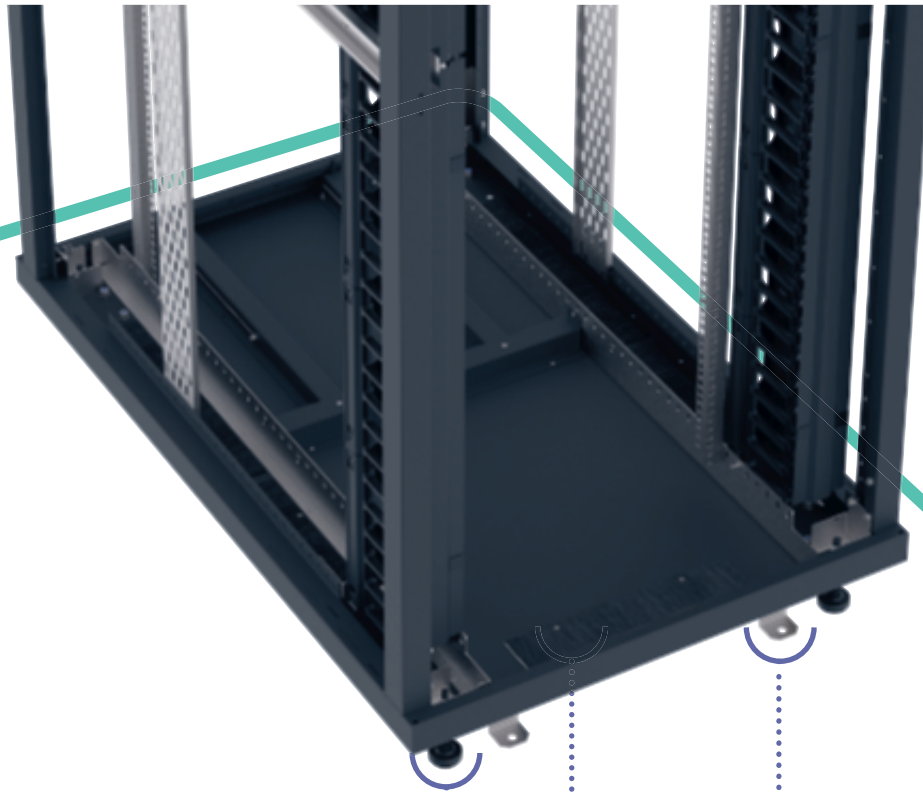

### CASTERS AND LEVELLING FEET\*

Casters are rotational type and can move any direction  
Front casters are lockable  
Load capacity per caster: Fixed: 150 kg, Moving: 112 kg  
Load capacity per levelling feet: 375 kg.  
Levelling feet: Possible to adjust height of the feet  
from the floor.

### FLOOR FIXING KIT\*

Fixing the cabinet to floor for better stability. 4-point fixing.  
Galvanized sheet metal

### FAN MODULE\*

4 or 6 pcs of fan on a module, with ON/OFF,  
analog thermostat functions.  
Complete inner wiring. 1U.

### LIGHTING KIT\*

Equipped with magnets.

### GROUNDING CONTINUITY

Grounding cables for all metal components.  
Cable connections with bolts and nuts for all  
doors.

### BRUSHED CABLE ENTRY

For the width 800 mm cabinets, there are  
5 pieces; 4 pieces on both sides and 1 pcs at  
the rear. The dimensions of the cable entries  
are different according to the depth of the  
cabinet.

For 1000 mm depth:  
80 mm x 350 mm (x4), 80 mm x 350 mm (x1)

For 1200 mm depth:  
80 mm x 350 mm (x1), 80 mm x 450 mm (x4)

(\* ) Option



### FIXED AND SLIDING SHELF\*

Fixing points at the sides of rear and front 19" uprights. Vented for air circulation, adjustable depth, sheet steel material. For depth 1000 mm cabinets.

### CABLE TRAY\*

Option from 42U to 47U,  
W=100 mm.

### FINGER TYPE VERTICAL MANAGER\*

Option for patchcords from 42U to 47U.  
Professional cabling with finger type structure makes the user's work easier. It provides more optimal using area in the cabinet.

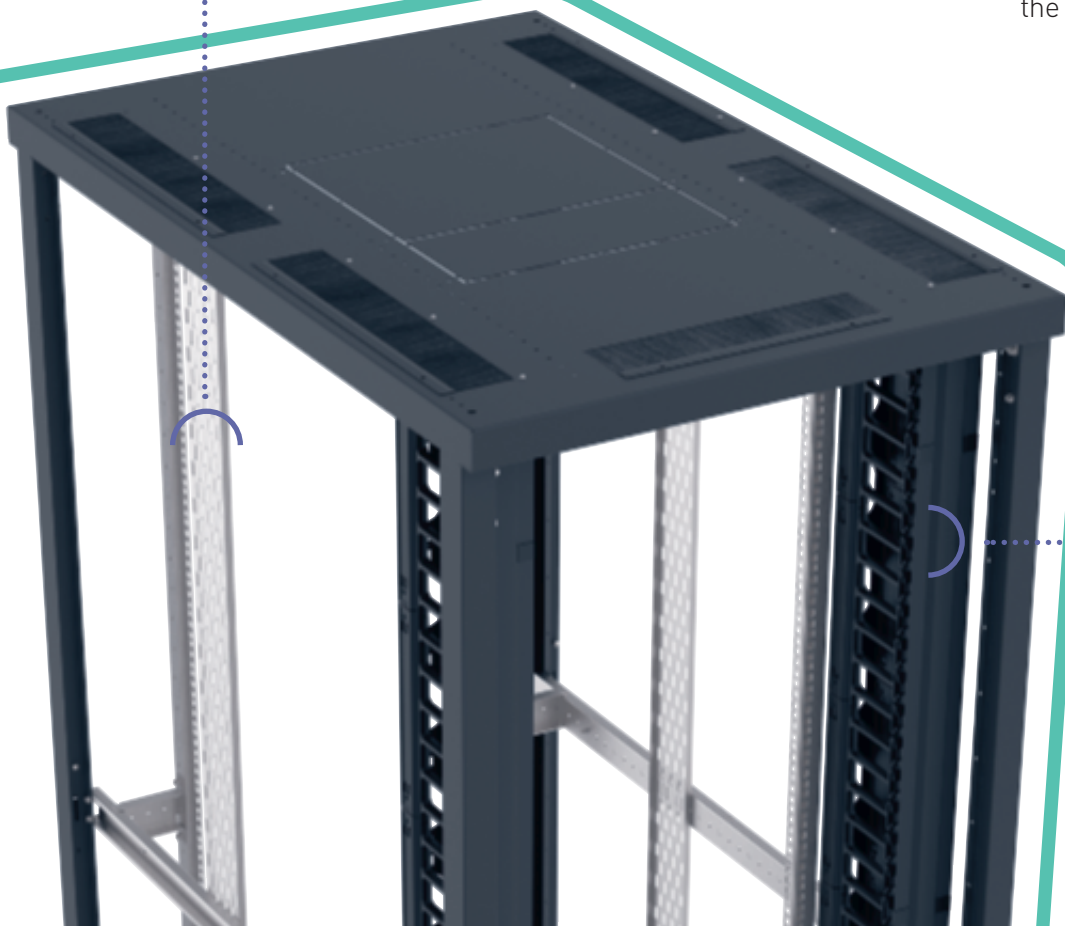

The image is for  
the width of  
800 mm cabinet

# LINKEO DATA CENTER

How to create a server cabinet?

## Select frame

without doors, side panels, levelling feet  
and grounding busbar



Doors



Side panels



Accessories

CABINET SIDE PANELS

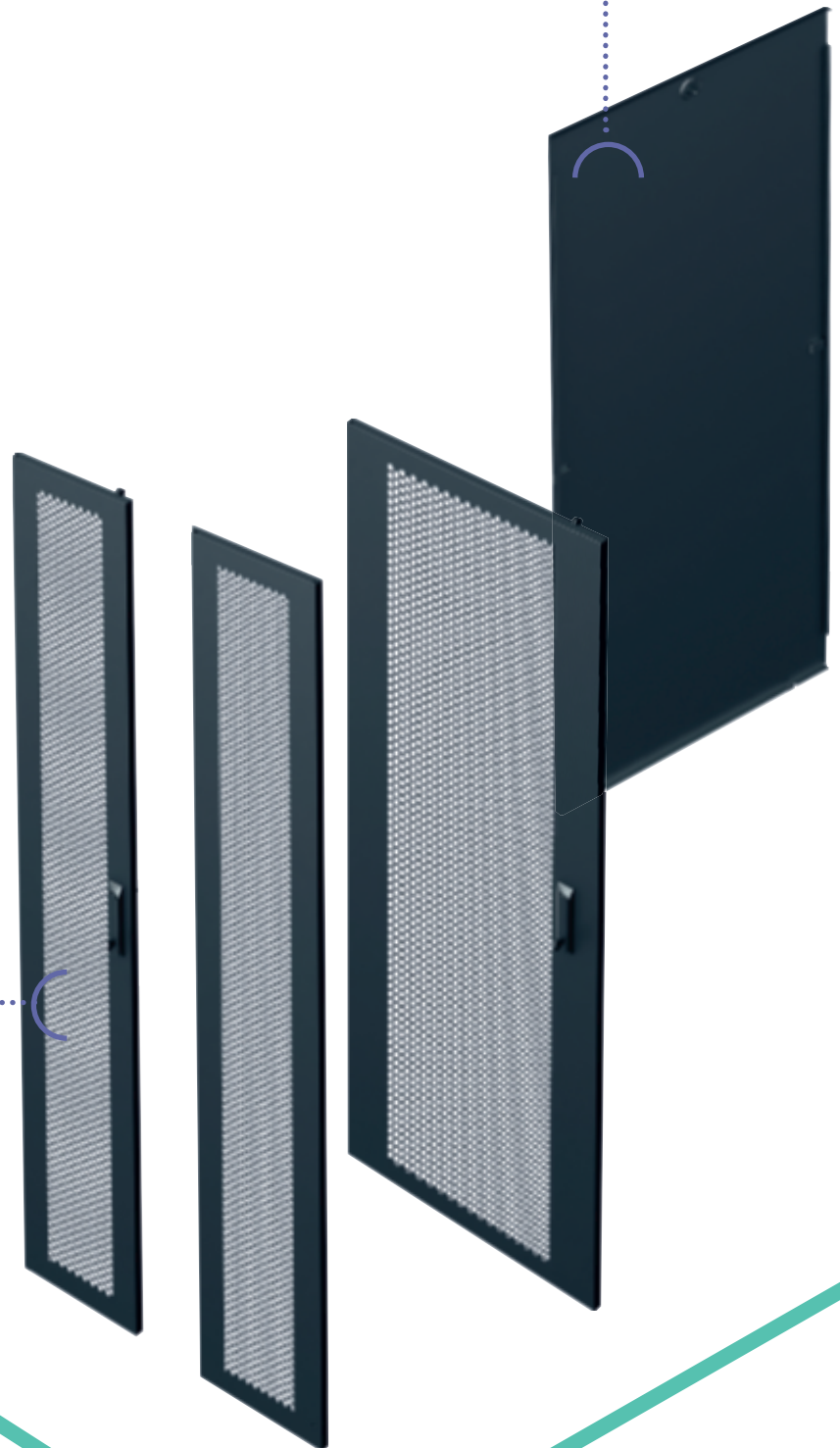

19" CABINET FRAME

CABINET DOORS  
Single opening

ACCESSORIES

- Plinths
- Casters
- Levelling feet
- Raised floor support
- Anti-tilt bar
- Floor fixing
- Vertical cord manager
- Cable tray
- Fan modules
- PDU holder
- Grounding busbar

# LINKEO DATA CENTER

Corridor Solutions

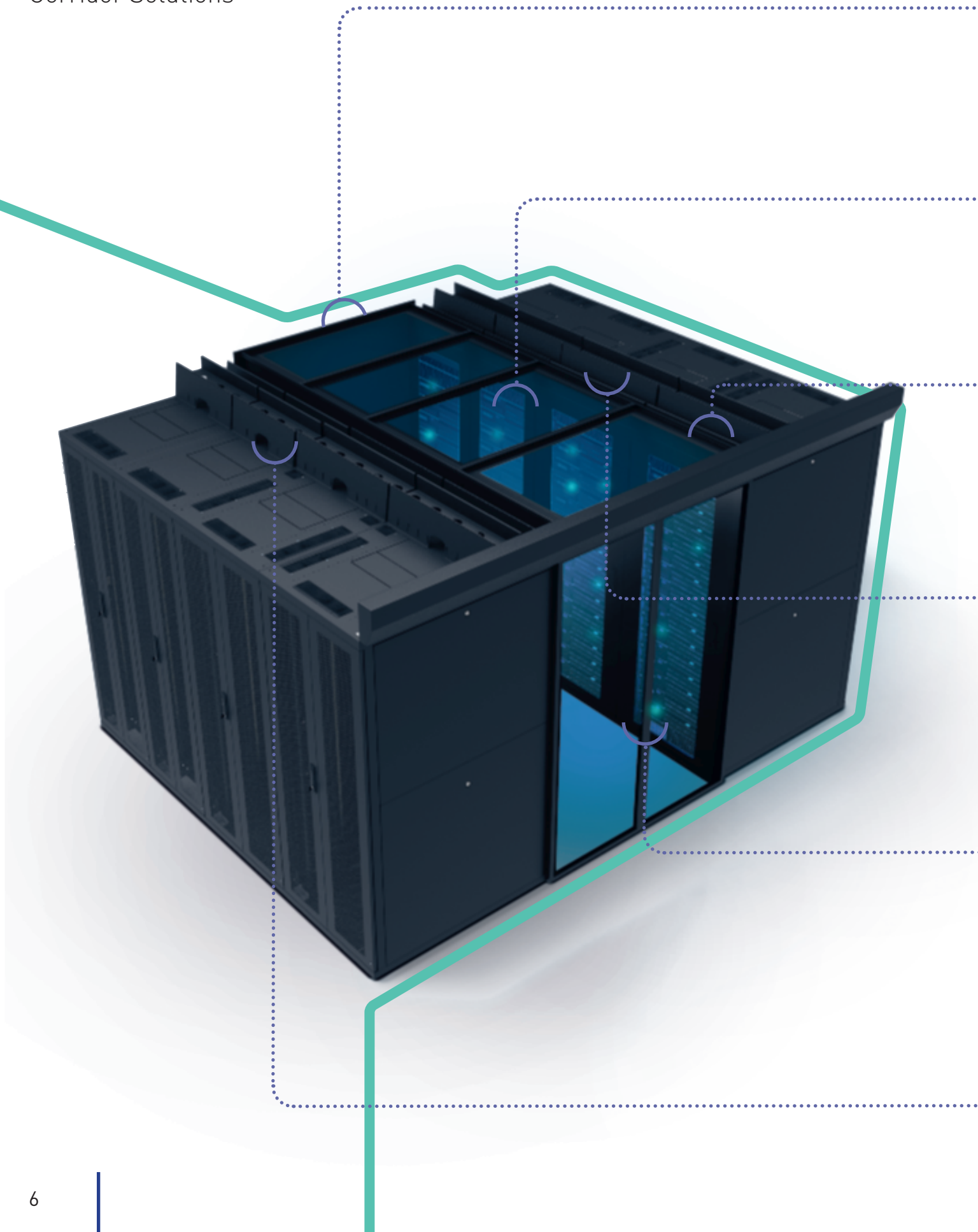





### **CORRIDOR REAR PANEL MODULES**

To close the back of aisle containment system.

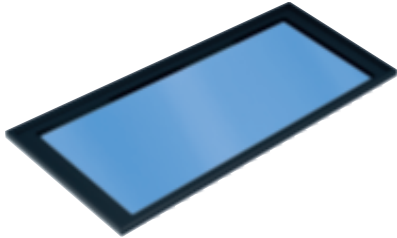

### **TOP PANEL MODULES**

Easy fixable top panel using to close the top of hot/cold aisle containment. Polycarbonate (4 mm) closing with reinforced metal frame.

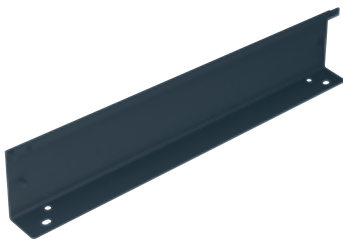

### **TOP COVER PANEL**

For close the top of hot/cold aisle containment. Transparent roof panels providing light transmission (Polycarbonate 4 mm). Width: from 600 mm to 800 mm - Height 120 mm



### **TOP COVER CABLE SEPARATOR (A TYPE)**

Separate cable inlet for data and energy cables, and separate overhead cable trays and dividers minimize the electromagnetic and physical interference. A type separator have H=120 mm and W=600/800 mm options.

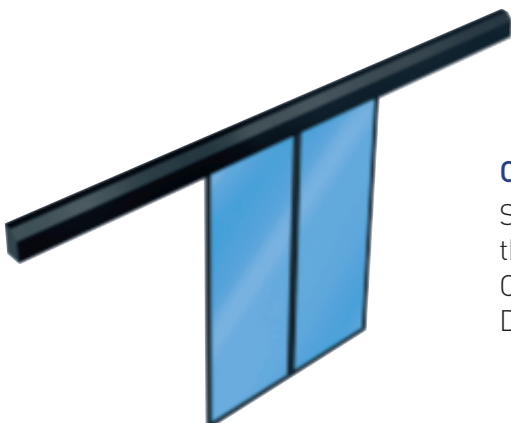

### **CORRIDOR DOORS**

Sliding doors providing an airtight enclosure for the aisle containment system. Opening and exit with hand sensor. Dimensions: 42/47U - width 1200 mm.



### **TOP COVER CABLE SEPARATOR (M TYPE)**

Server cabinets offer professional and highly secured management of high density data and power cables. M Type separator have H=200 mm and W=600/800 mm options.

# Linkeo Data Center 19" server cabinets

## cabinets and equipment



4 468 00



4 468 20



4 468 40



4 468 50



4 468 60

Technical characteristics p. 12

Pack	Cat.Nos	19" server cabinets																																				
		<p>19" freestanding server cabinets for data storage, server housing, infrastructural cabling and have also solutions for hot/cold corridor datacenter architecture</p> <p>IP 20 baying cabinets</p> <p>1500 kg load carrying capacity</p> <p>Equipped with 4 x 19" uprights with U marking and adjustable depth</p> <p>Pre-cut cable entries (top and bottom)</p> <p>Cut-out at the top for fan kit</p> <p>Black RAL 9005</p> <p><b>Complete server cabinets (ready assembled)</b></p> <p>Equipped with:</p> <ul style="list-style-type: none"> <li>- Single front and rear microperforated 80% door</li> <li>- 2 side panels</li> <li>- levelling feet</li> <li>- grounding kit</li> </ul>																																				
		<table border="1"> <thead> <tr> <th>Capacity</th> <th>Height (mm)</th> <th>Width (mm)</th> <th>Depth (mm)</th> </tr> </thead> <tbody> <tr> <td>42 U</td> <td>2052</td> <td>600</td> <td>1000</td> </tr> <tr> <td>42 U</td> <td>2052</td> <td>600</td> <td>1200</td> </tr> <tr> <td>42 U</td> <td>2052</td> <td>800</td> <td>1000</td> </tr> <tr> <td>42 U</td> <td>2052</td> <td>800</td> <td>1200</td> </tr> <tr> <td>47 U</td> <td>2274</td> <td>600</td> <td>1000</td> </tr> <tr> <td>47 U</td> <td>2274</td> <td>600</td> <td>1200</td> </tr> <tr> <td>47 U</td> <td>2274</td> <td>800</td> <td>1000</td> </tr> <tr> <td>47 U</td> <td>2274</td> <td>800</td> <td>1200</td> </tr> </tbody> </table>	Capacity	Height (mm)	Width (mm)	Depth (mm)	42 U	2052	600	1000	42 U	2052	600	1200	42 U	2052	800	1000	42 U	2052	800	1200	47 U	2274	600	1000	47 U	2274	600	1200	47 U	2274	800	1000	47 U	2274	800	1200
Capacity	Height (mm)	Width (mm)	Depth (mm)																																			
42 U	2052	600	1000																																			
42 U	2052	600	1200																																			
42 U	2052	800	1000																																			
42 U	2052	800	1200																																			
47 U	2274	600	1000																																			
47 U	2274	600	1200																																			
47 U	2274	800	1000																																			
47 U	2274	800	1200																																			

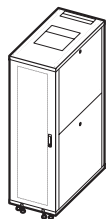

Pack	Cat.Nos	Server cabinet frame																																				
		<p>Cabinet frame without doors, side panels, levelling feet</p> <table border="1"> <thead> <tr> <th>Capacity</th> <th>Height (mm)</th> <th>Width (mm)</th> <th>Depth (mm)</th> </tr> </thead> <tbody> <tr> <td>42 U</td> <td>1967</td> <td>600</td> <td>1000</td> </tr> <tr> <td>42 U</td> <td>1967</td> <td>600</td> <td>1200</td> </tr> <tr> <td>42 U</td> <td>1967</td> <td>800</td> <td>1000</td> </tr> <tr> <td>42 U</td> <td>1967</td> <td>800</td> <td>1200</td> </tr> <tr> <td>47 U</td> <td>2189</td> <td>600</td> <td>1000</td> </tr> <tr> <td>47 U</td> <td>2189</td> <td>600</td> <td>1200</td> </tr> <tr> <td>47 U</td> <td>2189</td> <td>800</td> <td>1000</td> </tr> <tr> <td>47 U</td> <td>2189</td> <td>800</td> <td>1200</td> </tr> </tbody> </table>	Capacity	Height (mm)	Width (mm)	Depth (mm)	42 U	1967	600	1000	42 U	1967	600	1200	42 U	1967	800	1000	42 U	1967	800	1200	47 U	2189	600	1000	47 U	2189	600	1200	47 U	2189	800	1000	47 U	2189	800	1200
Capacity	Height (mm)	Width (mm)	Depth (mm)																																			
42 U	1967	600	1000																																			
42 U	1967	600	1200																																			
42 U	1967	800	1000																																			
42 U	1967	800	1200																																			
47 U	2189	600	1000																																			
47 U	2189	600	1200																																			
47 U	2189	800	1000																																			
47 U	2189	800	1200																																			
		<p><b>Front or rear cabinets doors</b></p> <p>Galvanised sheet metal</p> <p>80% perforations</p> <p>Can open 220°</p> <p>Equipped with locking mechanism (3 point lock) and hinge system</p> <p>Includes 1 piece of door with key</p> <p><b>Reversible single opening</b></p> <ul style="list-style-type: none"> <li>For cabinets 42 U - 600mm</li> <li>For cabinets 42 U - 800mm</li> <li>For cabinets 47 U - 600mm</li> <li>For cabinets 47 U - 800mm</li> </ul> <p><b>Double opening (in 2 parts)</b></p> <ul style="list-style-type: none"> <li>For cabinets 42 U - 600mm</li> <li>For cabinets 42 U - 800mm</li> <li>For cabinets 47 U - 600mm</li> <li>For cabinets 47 U - 800mm</li> </ul>																																				

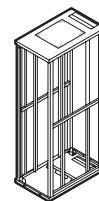

Pack	Cat.Nos	Cabinet side panels
		<p>Fixed to cabinet by cylindrical key lock</p> <p>Set of 2 side panels</p> <p>Side panel in 1 piece for 1000 mm deep cabinets</p> <p>Side panel in 2 pieces (half cabinet height) for 1200 mm deep cabinets</p> <ul style="list-style-type: none"> <li>For cabinets 42 U - 1000mm (1 part)</li> <li>For cabinets 42 U - 1200mm (2 parts)</li> <li>For cabinets 47 U - 1000mm (1 part)</li> <li>For cabinets 47 U - 1200mm (2 parts)</li> </ul>

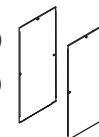

# Linkeo Data Center 19" server cabinets

## accessories

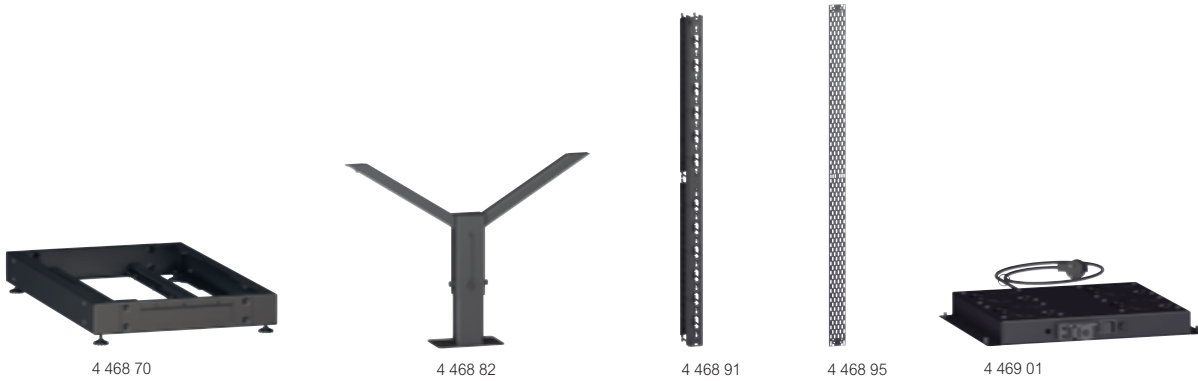

Pack	Cat.Nos	Plinths
1	4 468 70	Metal plinths consisting of 4 corner blocks Height : 100 mm
1	4 468 71	Width 600mm - depth 1000 mm
1	4 468 72	Width 600mm - depth 1200 mm
1	4 468 73	Width 800mm - depth 1000 mm
1	4 468 73	Width 800mm - depth 1200 mm
1	4 468 80	<b>Casters and levelling kit</b> Set of 4 casters, 2 of which are lockable Must be use with levelling feet Load capacity per caster : fixed (150 kg), moving (112 kg)
1	4 468 81	Levelling feet M10X70 Set of 4 pcs Possible to adjust height of the feet from the floor Load capacity per levelling feet : 375 kg
1	4 468 82	<b>Raised floor support kit</b> To fix the cabinet to floor for more stability Adjustable height from 400 to 700 mm Set of 2 pcs
1	4 468 83	For 600mm width cabinets
1	4 468 83	For 800mm width cabinets
1	4 468 86	<b>Anti-tilt bar</b> Bars provide a high level of stability for the products
1	4 468 87	<b>Floor fixing kit</b> Galvanised sheet metal 4-points fixing between the cabinet and the floor - front/rear, right/left Must be use with casters and levelling feet Cabinets floor fixing kit
1	4 469 47	<b>Baying kit</b> Set of 2 pcs

Pack	Cat.Nos	Vertical patchcord manager
1	4 468 91	To guide and manage the cords vertically Set of 2 pcs Compatible only with 800 mm wide cabinets
1	4 468 92	<b>Finger type</b> Particularly suitable for optical cables 42 U
1	4 468 92	47 U
1	4 468 93	<b>Metal</b> Particularly suitable for heavier cables 42 U
1	4 468 94	47 U
1	4 468 95	<b>Cable tray</b> Perforated metal tray to fix cables on cabinet sides 42 U - width 100 mm
1	4 468 96	47 U - width 100 mm
1	4 469 01	<b>Fan modules</b> 4 or 6 pcs of fan on a module, with On/Off switch, analog thermostat functions Complete inner wiring 230 V~ Power supply cord 3 m
1	4 469 02	4 fans, 2P+E European standard (French - German standard) plug
1	4 469 03	4 fans, 2P+E British standard plug
1	4 469 04	6 fans, 2P+E European standard (French - German standard) plug
1	4 469 04	6 fans, 2P+E British standard plug
1	4 468 97	<b>PDU holder</b> To mount PDUs vertically To be fixed in the corner of the cabinet Set of 2 pcs, for 1 PDU
1	4 468 98	<b>Grounding busbar kit</b> 6 pieces earthing leads + copper busbar



6 465 07



6 465 20

Pack	Cat.Nos	Linkeo fixed shelves
1	6 465 07	Screw fixing on 4 x 19" uprights Height 1 U Max. load: 50 kg Black RAL 9005 Shelf depth 825 For depth 1000 mm
1	6 465 10	Linkeo telescopic shelves Screw fixing on 4 x 19" uprights. Height 1 U Max. load: 30 kg. Black RAL 9005 Shelf depth 825 For depth 1000 mm
1 1	6 465 20 6 465 21	19" management panels Fitted with cable guide rings 1 U 2 U
1 1	0 465 32 0 465 33	19" blanking plates Black RAL 9005 Plastic, direct clipping 1 U 2 U
1	0 464 91	LED Lighting with switch 60° swivel Prewired with 2 m length power cord Magnets fastening

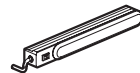
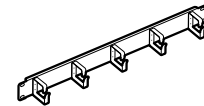
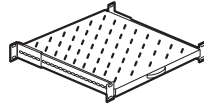
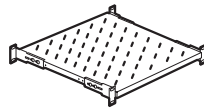

## Tests and complied standards

- 1) ISO 9001:2015 Quality Management System
- 2) ISO 14001:2015 Environmental Management System
- 3) ISO 27001:2013 Information Security Management System
- 4) ISO 45001:2018 Occupational Health and Safety Management System
- 5) 19" device mounting uprights IEC 297-1
- 6) EN 61587-1 Mechanical structures for electronic equipment
- 7) All cabinet sizes complies with IEC 297-2

## Resistance to environmental conditions and corrosion:

- stability, mechanical safety, resistance to static, dynamic and mechanical loads
  - resistance to vibration, mechanical shock and impact
  - degrees of mechanical protection provided by the enclosure (IP20), electrical grounding continuity
  - fire and flame resistance
- Have been tested according to the standard - EN 61587-1 with the normative standards: IEC 60917, IEC 60297, IEC 60068-1, IEC 60068-2, IEC 60695-11-10, IEC 60950-1, contained and certified by the notified organizations

## TSE certificate number:

- 003788-TSE-08/02

## EAC certificate number:

- 0443637, 0776963, 0345864, 0401678, 0776653

## Corrosion:

ISO 9227 Standard complied by the test report METALTEK AB-0547-T / 0157-1

## Transport:

- ETS 300 019-1-2 Class 2-3 Comply with internal testing

## Storage:

- ETS 300 019-1-1 Class 1-2 Comply with internal testing

## Surface finish:

Electrostatic powder coated c/with surface treatment, 80 +/-5 micron paint thickness

# Linkeo Data Center corridor and server cabinets

## airflow solutions

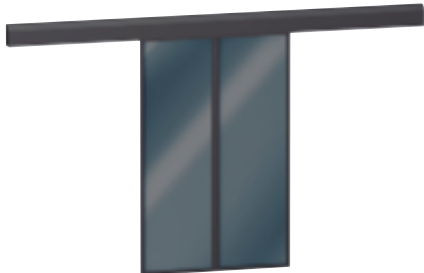

4 469 21



4 469 12



4 469 50

In data center rooms, to optimize cooling efficiency in data center

Pack	Cat.Nos	Corridor doors
		Sliding doors providing an airtight enclosure for the aisle containment system Double opening Opening and exit with hand sensor Tempered glass Corridor door fixing module included Can be connected to system to force the door to open or close (e.g fire systems) Equipped with 2 batteries inside which activates automatically and keeps the door running incase of a power cut
1	4 469 20	42 U - width 1200 mm - for cabinet depth 1000 mm
1	4 469 21	42 U - width 1200 mm - for cabinet depth 1200 mm
1	4 469 22	47 U - width 1200 mm - for cabinet depth 1000 mm
1	4 469 23	47 U - width 1200 mm - for cabinet depth 1200 mm

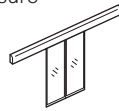

Pack	Cat.Nos	Corridor rear panel modules
		To close the back of the aisle containment system When you don't need a second door
1	4 469 30	42 U cabinets height - 1200 mm corridor width
1	4 469 31	47 U cabinets height - 1200 mm corridor width



Pack	Cat.Nos	Top panel module
		To close the top of hot/cold aisle Polycarbonate (4 mm thickness) with reinforced metal frame To form a roof provide 1 top panel edge module and others top panel module
1	4 469 10	Top panel module, 600 x 1200 mm
1	4 469 11	Top panel module, 800 x 1200 mm
1	4 469 12	Top panel edge module, 600 x 1200 mm
1	4 469 13	Top panel edge module, 800 x 1200 mm

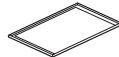

Pack	Cat.Nos	Top cover panel
		For close the top of hot/cold aisle containment Transparent roof panels providing high translucency / light transmission Polycarbonate (4 mm)
1	4 469 41	Width 600 mm, height 120 mm
1	4 469 42	Width 800 mm, height 120 mm
		<b>Air flow management top and bottom and side panels</b> To create an airtight enclosure
		<b>Top and bottom panels</b> Width 600 mm Width 800 mm
1	4 469 50	42 U, width 600 mm
1	4 469 51	42 U, width 800 mm
1	4 469 52	47 U, width 600 mm
1	4 469 53	47 U, width 800 mm
1	4 469 54	47 U, width 600 mm
1	4 469 55	47 U, width 800 mm
		<b>Side panels</b> 42 U, width 600 mm 42 U, width 800 mm 47 U, width 600 mm 47 U, width 800 mm
		<b>Top cover cable separator</b> Seperate cable inlet for data and energy cables, and seperate overhead cable trays and dividers minimize the electromagnetic and physical interference
1	4 469 43	A type, height 120 mm, width 600 mm
1	4 469 44	A type, height 120 mm, width 800 mm
1	4 469 45	M type, height 200 mm, width 600 mm
1	4 469 46	M type, height 200 mm, width 800 mm

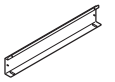

## Technical characteristics

### Index of protection

- IP20 according to EN 61587-1, IEC 60529 IP20: Protected against solid objects larger than 12.5 mm in diameter

### Front door structure

- Produced from galvanised sheet metal
- The door has 80% perforations to have a good air flow
- Provides enough space for patch cords between door and equipment
- Can open 220°

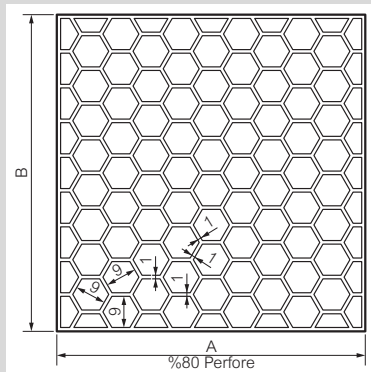

### Locking mechanism

- 3 point lock, handle with semi cylindrical barrel

### Hinge System:

- 3 pcs Zinc alloy Steel to fix the door

### Side panel structure

- Produced from DKP sheet metal
- Thickness is 1 mm
- Fixed to cabinet by cylindrical lock
- 2 pcs in one side

### Rear door structure:

- Produced from DKP sheet metal
- The flat door has 80% perforations to have a good air flow
- Can open 220°

### Locking mechanism

- 3 point lock, handle with semi cylindrical barrel

### Hinge System

- 3 pcs Zinc alloy Steel to fix the door

### Roof structure

- Produced from DKP sheet metal
- Suitable to fan module fixing
- Plenty of cable entry possibility
- Brush type cable entries

## Purchased product certification

### Sheet steel

EN 10346:20015 DX51D+Z, EN 10130:2006 DC01

### Electrostatic powder coat NG:

ISO 6860, ISO 2409, ISO 1520, ISO 2815, ISO 6272, ISO 6270-1, ISO 2812, ISO 9001, RoHS

### Glass

TS EN 12150-A, TS EN 1863-1

### Lock:

IEC 62474, REACH, RoHS

### Castors:

ISO 9001, TS EN 12532, RoHS

### Fan:

IEC 60335-2-80:2002, IEC 60335-1 2010

## Linkeo Data Center 19" server cabinets (continued)

### 19" Linkeo server width 600 mm

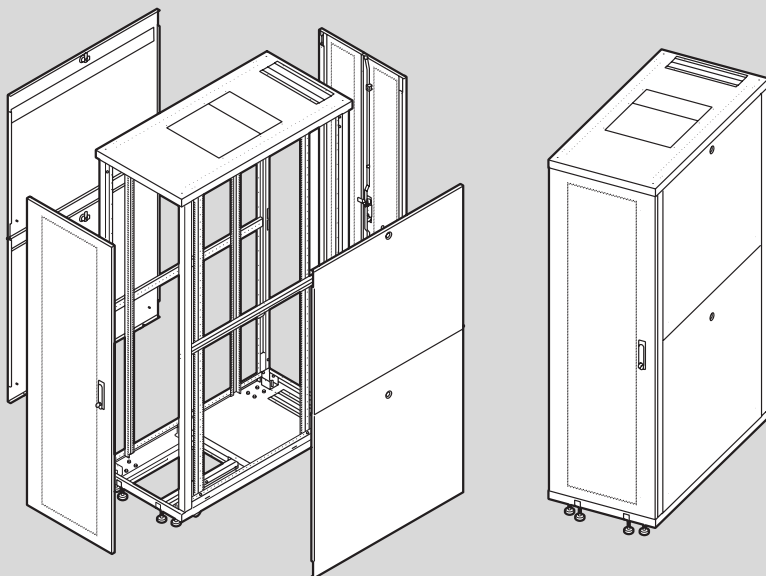

Depth 1000 mm: side panels in 1 part  
Depth 1200 mm: side panels in 2 parts

Cat. Nos	U size	Width overall (mm)	Depth overall (mm)	Depth max. mounting profile (mm)	Height vertical mounting profile (mm)	Height without levelling feet (mm)	Height with levelling feet min. (mm)	Height with casters (mm)
4 468 00/20	42	600	1000	830	1867	1967	2052	2047
4 468 01/21	42	600	1200	1030	1867	1967	2052	2047
4 468 04/24	47	600	1000	830	2089	2189	2274	2269
4 468 05/25	47	600	1200	1030	2089	2189	2274	2269

### 19" Linkeo server width 800 mm

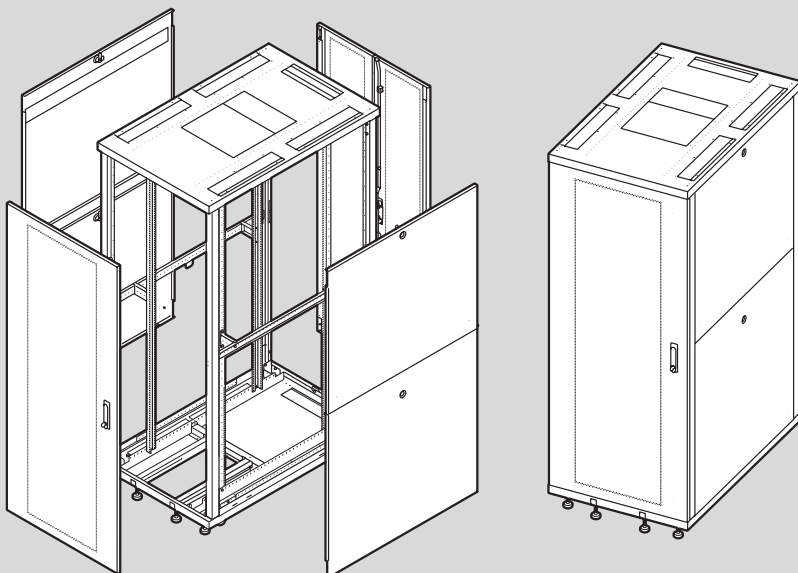

Depth 1000 mm: side panels in 1 part  
Depth 1200 mm: side panels in 2 parts

Cat. Nos	U size	Width overall (mm)	Depth overall (mm)	Depth max. mounting profile (mm)	Height vertical mounting profile (mm)	Height without levelling feet (mm)	Height with levelling feet min. (mm)	Height with casters (mm)
4 468 02/22	42	800	1000	830	1867	1967	2052	2047
4 468 03/23	42	800	1200	1030	1867	1967	2052	2047
4 468 06/26	47	800	1000	830	2089	2189	2274	2269
4 468 07/27	47	800	1200	1030	2089	2189	2274	2269

## Linkeo Data Center 19" server cabinets (continued)

### ■ Dimensions

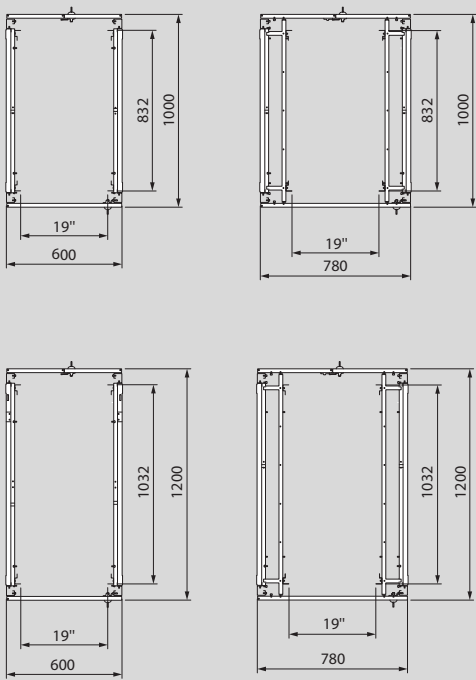

### ■ Roof options

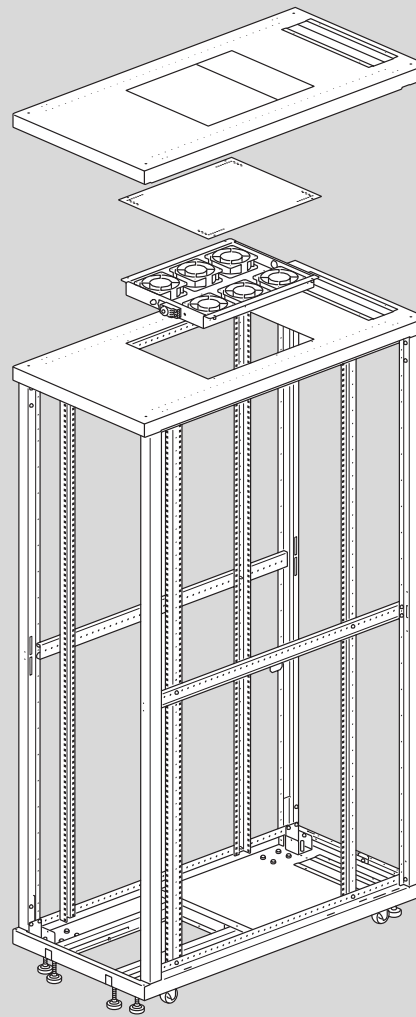



**Views**

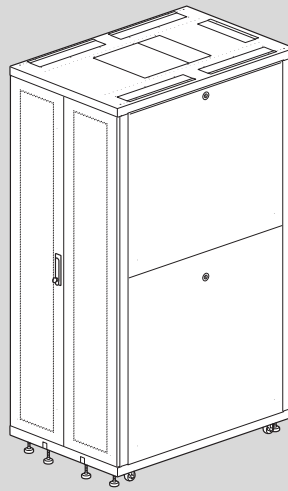
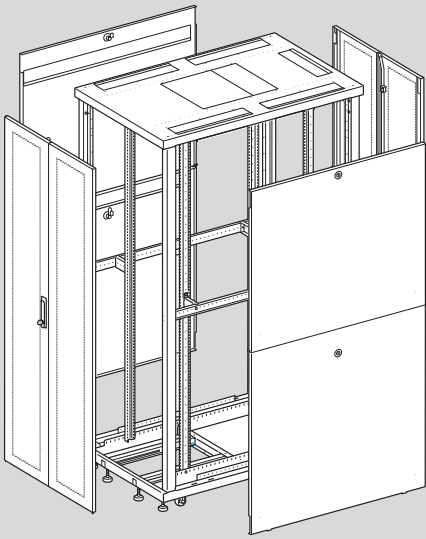

Iso view

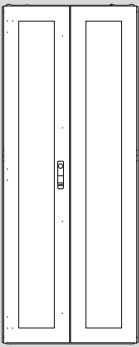

Front view

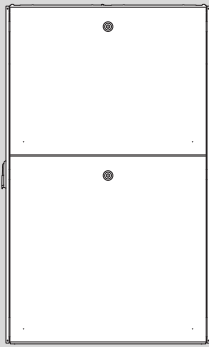

Side view

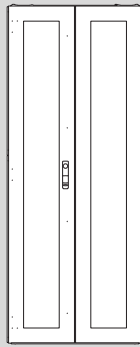

Rear view

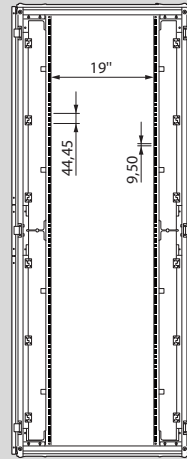

Front view

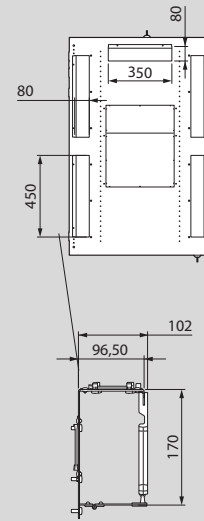

Organiser

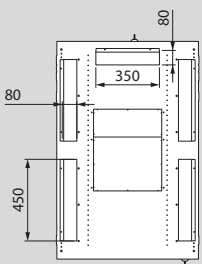

Top view

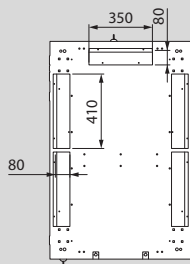

Bottom view

## Linkeo Data Center corridor

### ■ Automatic opening

**Wing Frame Material:**

Aluminium

**Glass:**

4+4 mm transparent laminated glass

**Carrier System:**

5x60x120 mm - 4 bracelets ; 40x60x2mm Alm. Profile posts

**Carrier Wide:**

3200 mm - 3600 mm (Depends to the cabinets depth)

**Security Sensor:**

Active 8 curtain photocell sensor

**Mechanism Wide:**

2500 mm

**Corridor Wide:**

1200x2240 m

**Wings:**

2 x moving wings, automatic

**Locking:**

Electro-mechanic locking systems

**Colour:**

RAL 9005

System is CE, TUV and ISO certificated

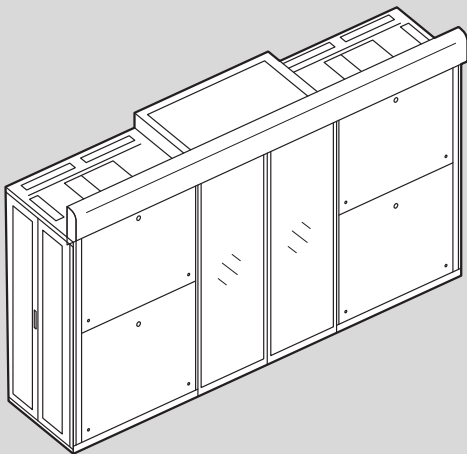





FOLLOW US  
ALSO ON

- ➔ [legrandgroup.com](http://legrandgroup.com)
- ▶ [youtube.com/user/legrand](https://youtube.com/user/legrand)
- f [facebook.com/Legrand](https://facebook.com/Legrand)
- t [twitter.com/Legrand](https://twitter.com/Legrand)
- p [pinterest.com/legrandgroup](https://pinterest.com/legrandgroup)
- 📷 [instagram.com/legrandnews](https://instagram.com/legrandnews)



**Headquarters**

128, avenue de Lattre de Tassigny  
87045 Limoges Cedex  
France  
Tel.: + 33 (0) 5 55 06 87 87  
Fax: + 33 (0) 5 55 06 88 88