

ACCESSORIES
FOR WIREMESH CABLE TRAYS

SAFETY, SCALABILITY,
AND TIME SAVING

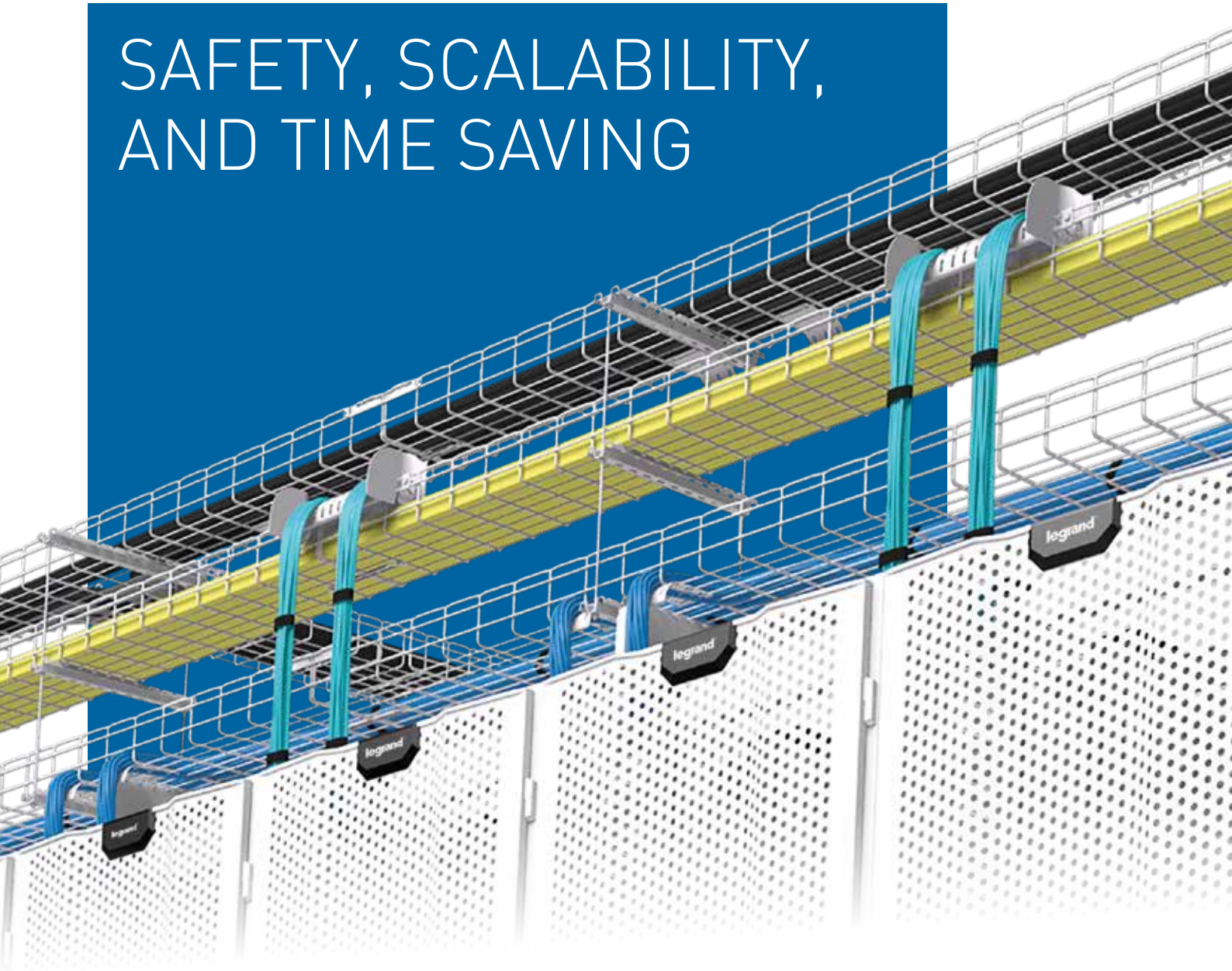

CABLE MANAGEMENT
IN DATA CENTERS

SAFETY & SCALABILITY AT THE HEART OF DATA CENTERS

The environment around modern data centers is extremely dynamic and constantly evolving. Cablofil wiremesh cable trays and cable management accessories dedicated to data centers are designed to ensure perfect compatibility with the various types of cable. They are “cable-friendly” (compliant with bending radiuses, provide optimum support, smooth surfaces, no protruding corners to prevent damage to the cables). They also save a great deal of time both during installation and future upgrades. Downtime is reduced and thanks to the wiremesh cable trays the installation is fully scalable (in the event of reconfiguration).

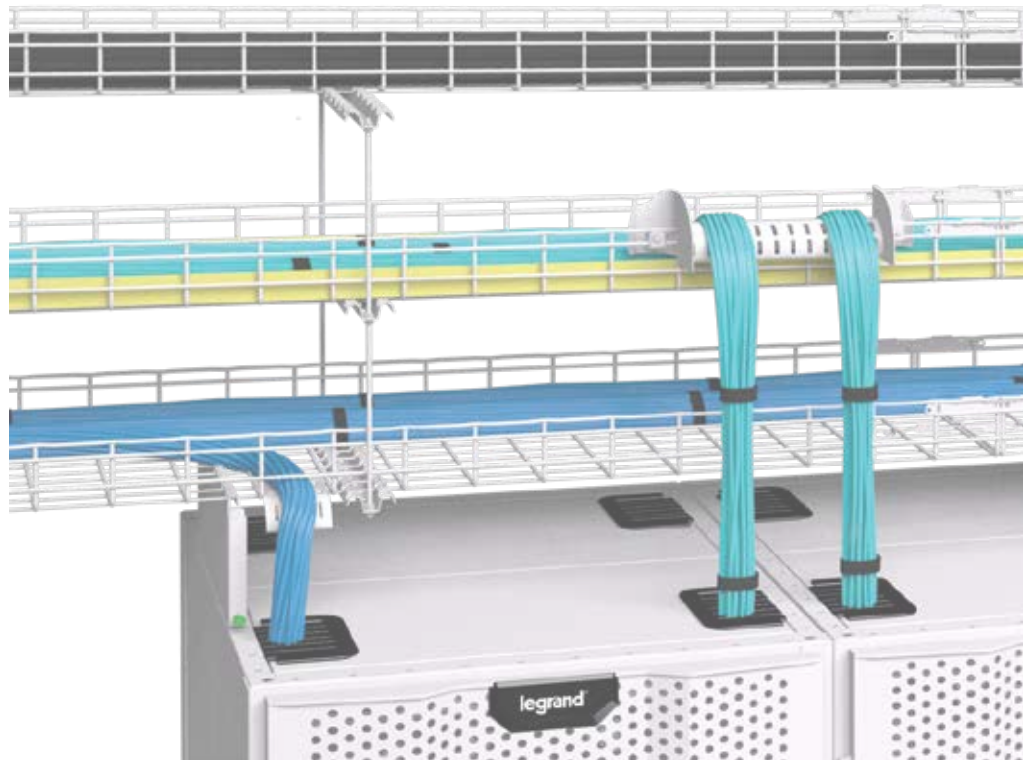

THE CABLOFIL RANGE OF WIREMESH CABLE TRAYS OFFERS MULTIPLE OPTIONS IN TERMS OF PERFORMANCE AND NUMEROUS BENEFITS THANKS TO ITS 90% OPEN STRUCTURE

- Makes it easier to visually inspect, access and maintain the cables, even in multi-level cable tray installations
- Reduces cable temperature rise for substantial savings on operating costs
- Minimises retention of dust
- Eliminates the risk of outbreak of fire and does not create dust during cutting operations, which can be done with pliers rather than a circular saw (safer, “clean” site).



A WIDE RANGE OF SIZES

Several heights (30/54/105/150 mm), widths between 50 and 900 mm and different finishes, as standard or configured to order to adapt perfectly to the specific requirements of data centers.

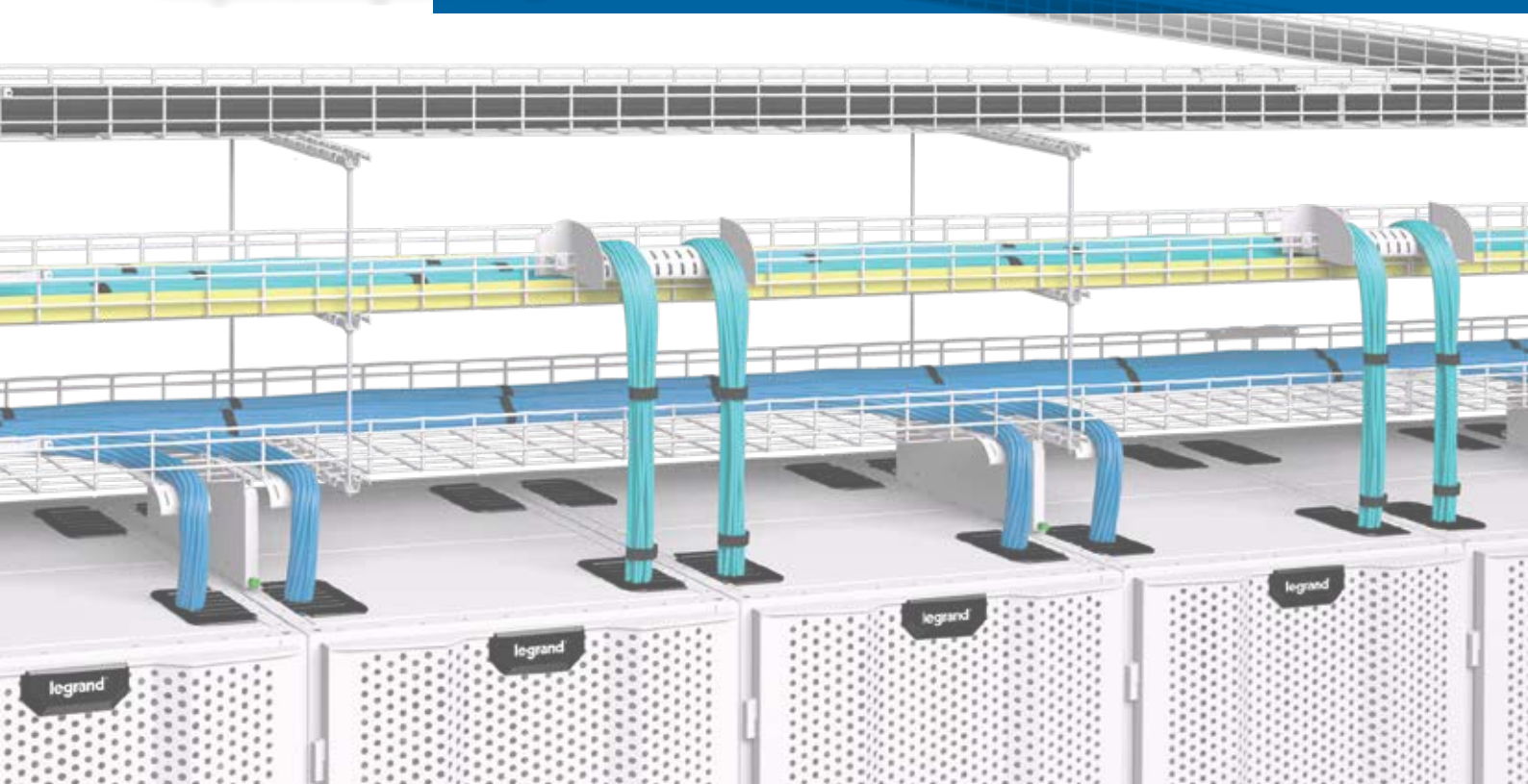

LESS INTERFERENCE

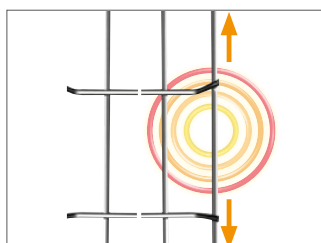

The steel structure can reduce electromagnetic interference and parasitic static loads.

SAFETY EDGE



The patented safety edge of Cablofil cable trays (T-joint system) and its special mechanical design allow cables to be carried and managed without the risk of damaging them.

TIME SAVING



FAS (Fast Assembly System) type couplers and supports simplify installation and save a great deal of time.

CHOICE OF COLOURS

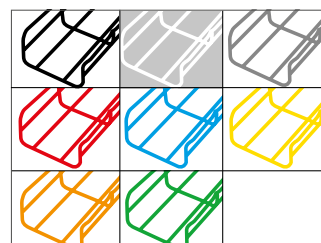

Depending on the installation, you can either choose from our standard colours or ask for a bespoke colour.

OPTIMUM CABLE PROTECTION & TIME SAVING

ACCESSORIES FOR DOWNWARD CABLE RUNS

UDO DROPOUT

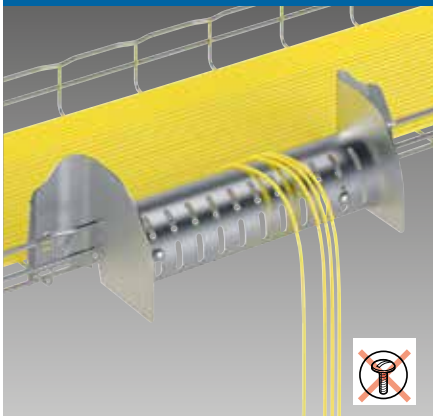

Ideal for copper, fibre optic or PoE cables.

- Available in 4 widths from 200 to 600 mm
- Optimal 120° bending radius for cable feedthrough
- Side partitions for holding the cables in place
- Quick clip-on fixing on the side of cable trays
- Finishes: **EZ** **BL** **WH**
- Oblong cut-outs for feeding through flexible cable ties to secure the cables.

DROPOUT KIT

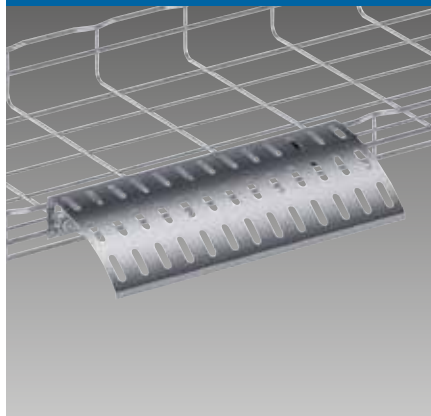

Compatible with any type of cable: copper, fibre optic or PoE

- Optimal bending radius for cable feedthrough
- Fixing accessories supplied (screws)
- Finishes: **GS** **BL** **WH**
- Oblong cut-outs for feeding through flexible cable ties to secure the cables.

DEV 100 AND 50 DROPOUTS

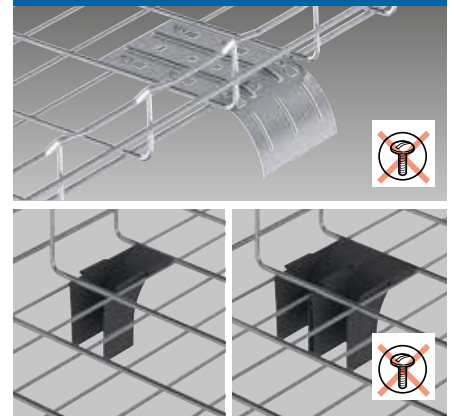

Compatible with any type of cable: copper or fibre optic

- Prevents cables becoming deformed where they enter and exit the cable tray
- Clips in place without tools
- Suitable for all widths of Cablofil cable tray
- The DEV 50 dropout is certified UL94 V-0.

TAP-OFF ACCESSORIES

For increased cable protection at junctions

- Made of ABS
- Quick fixing with cable ties (supplied)
- Compatible with CF 54, CF 105 and CF 150 wiremesh cable trays
- Can be cut to the correct height (pre-cut).

EZT90RS ANGLE SHIELD

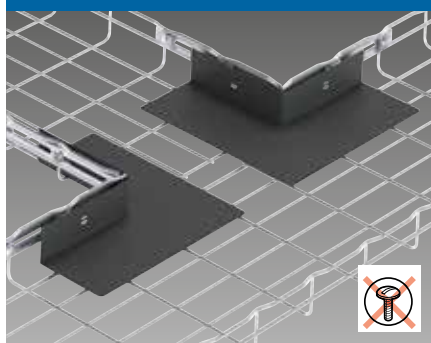

FOR USE WITH THE EZT 90 COUPLER

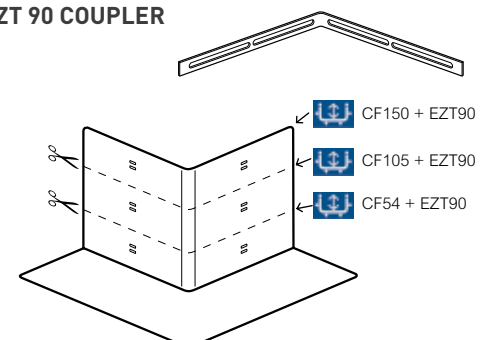

Designed to optimise installation time, these accessories are compatible with any type of copper or fibre optic cable. They ensure compliance with the installation rules, mainly as regards the cable bending radius on changes of direction (downward runs, tap-offs).

This radius must be wide enough to ensure optimum signal propagation and maintain the integrity of the cables.



Particularly suitable for fibre optic cable, due to the smooth surface and curved shapes that allow the cables to be fed through without damaging them.

Compatible with cable trays:

- CF 54: 300 to 600 mm wide
- CF 105: 150 to 600 mm wide
- CF 150: 200 to 900 mm wide
- Made of polycarbonate
- Quick clip-on fixing on the side of cable trays, without the need to cut them
- Pass the cables under the fixing point
- Oblong cut-outs for feeding through flexible cable ties to secure the cables.

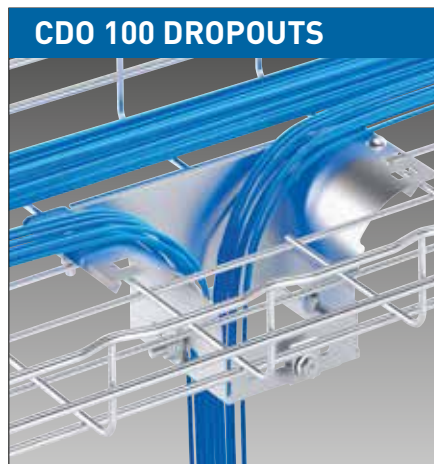

Specially designed for high-capacity data centers, where the downward cable run is often needed when the cables are already in place (upgrading the installation).

- The dropout clips on, before or after the cables are fitted
- Particularly robust, made of metal, to ensure that copper or fibre optic cable bundles stay in place
- Ensures an optimum bending radius to prevent damage to the cables
- Can take a 100 mm wide vertical Cablofil cable tray (CF 54/100 or CF 105/100) for strong cable fixing
- Finishes: **EZ** **BL**
- Can be reused if there is a change of configuration.

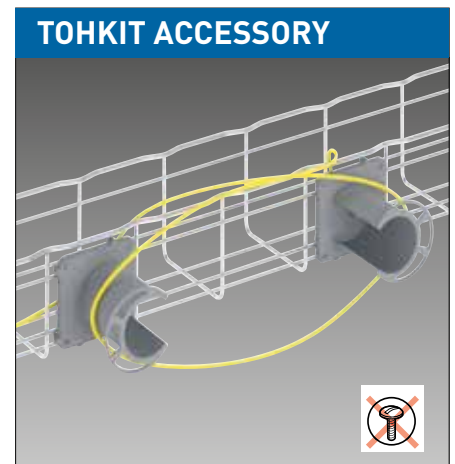

Specially designed for fibre optic cables

- Can be fixed on the side of cable trays or on the bottom (in the cable tray)
- Made of ABS
- Quick clip-on fixing using the Plexo 80 base (supplied)
- Compatible with all Cablofil lengths.

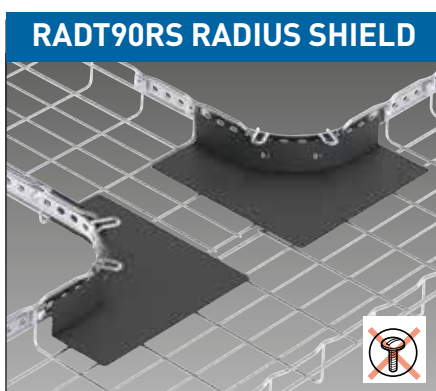



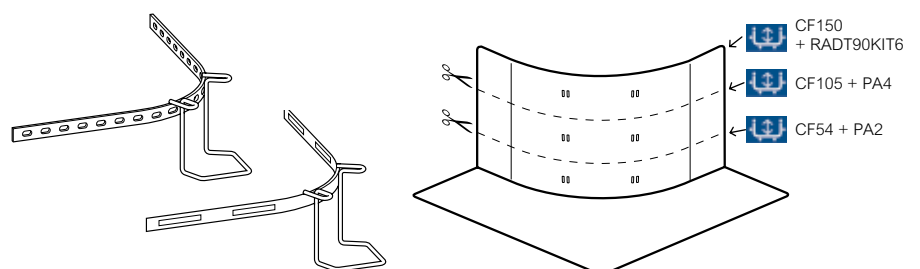









FOR USE WITH PA OR RADT90KIT6 ACCESSORIES









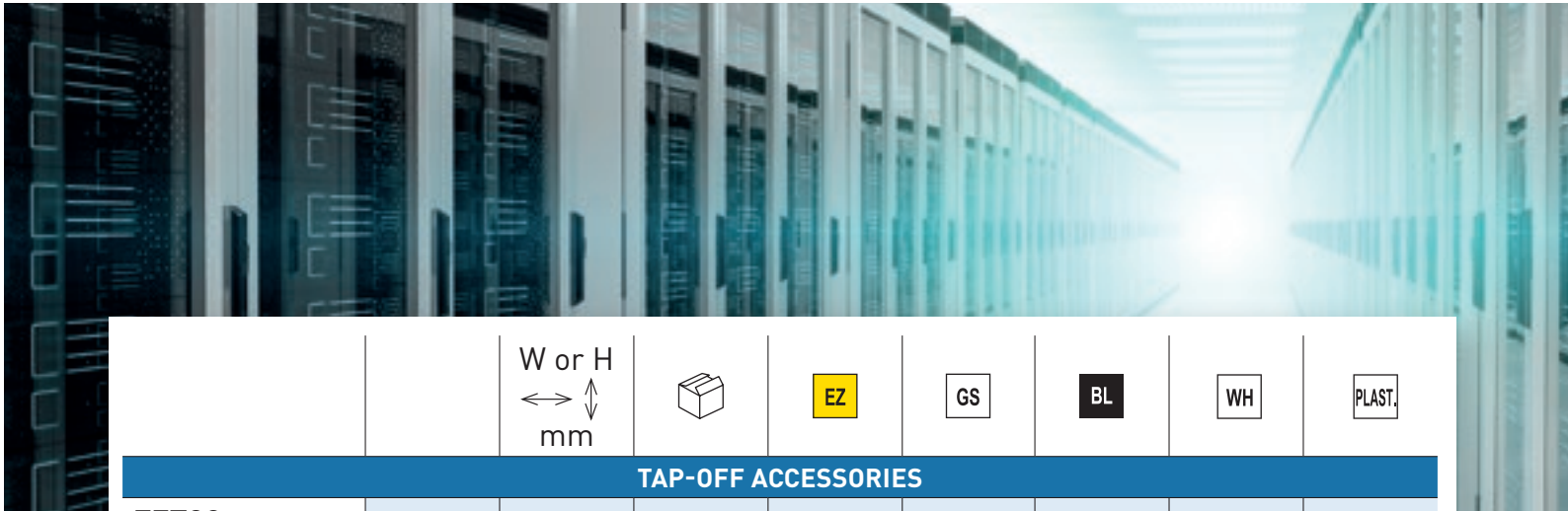





THE RANGE OF ACCESSORIES

The range of accessories for Cablofil wiremesh cable trays is divided into 3 separate families to suit each configuration

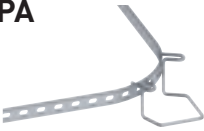
		W ↔ mm						
ACCESSORIES FOR DOWNWARD CABLE RUNS								
UDO 	UDO8	200	1	944 917	-	944 975	945 104	-
	UDO12	300	1	944 918	-	944 976	945 105	-
	UDO18	450	1	944 919	-	944 977	-	-
	UDO24	600	1	944 920	-	944 978	-	-
DROPOUTKIT 	DROPOUT KIT	311	1	-	942 895	942 896	944 613	-
OTDOFAS 	OTDOFAS		1	-	-	-	-	944 779
DEV100 	DEV100 CABLEXIT		1	-	585 160	-	943 120	-
DEV50 	DEV50 CABLEXIT		1	-	-	-	-	 350 535
CDO 	CDO100		1	945 245	-	945 246	-	-



		W or H ↔↕ mm						
TAP-OFF ACCESSORIES								
EZT90 	EZT90	225/225	1	840 231	-	-	-	-
EZT90RS 	EZT90RS		2	-	-	-	-	944 768
PA 	PA1 PA2 PA4	H mm ↕ 30 54 105	1 1 1	840 101 840 111 840 131	- - -	- - -	- - -	- - -
RADT90KIT6  x2	RADT90 KIT6 (supplied with screws and CE 40 couplers)	150	1	942 942	-	-	-	-
RADT90RS 	RADT90 RS		2	-	-	-	-	944 770
COILING ACCESSORY								
TOHKIT 	TOHKIT		1	-	-	-	-	944 707
OTHER ACCESSORIES								
CABLOGRIP 	CABLO- GRIP	W mm ↔ 5000	1	-	-	-	-	559 677

MATERIALS AND FINISHES

 Electrogalvanising after manufacturing Standard EN ISO 2081

 Continuous galvanisation prior to manufacturing using the Sendzimir process Standard EN 10346

 Zinc-Magnesium prior to continuous manufacturing using the Sendzimir process Standard EN 10346

 Black

 White

 Plastic



International customer service

1 Route de Semur
21500 MONTBARD - France
+33 3 80 89 58 15
+33 3 80 89 58 97

Explore our products: www.cablofil.biz
Cablofil worldwide: www.cablofil.com

A Group brand |  **legrand**[®]