

LB PLUS DATA



BUSBAR TRUNKING
FOR LIGHTING
MANAGEMENT





LB PLUS DATA

LB PLUS DATA THE NEW LIGHTING MANAGEMENT BUSBAR TRUNKING SYSTEM

The management of artificial light is essential for ensuring both better comfort and energy savings, with consequent reduction of operating costs. It is with these 2 objectives in mind that **LB PLUS DATA** was developed, the new busbar trunking system with an internal BUS that can be used for the management of DALI or 1-10V protocol based lighting.

EFFICIENT DISTRIBUTION OF POWER AND MANAGEMENT OF LIGHTING



JUST ONE BUSBAR TRUNKING SYSTEM FOR ALL LIGHTING MANAGEMENT SOLUTIONS

LB PLUS DATA, available in 25, 40 and 63 A, can be used for lighting management in the industrial and service sectors and integrates with the Legrand lighting management solutions.

Distribution of energy consumption in the service sector

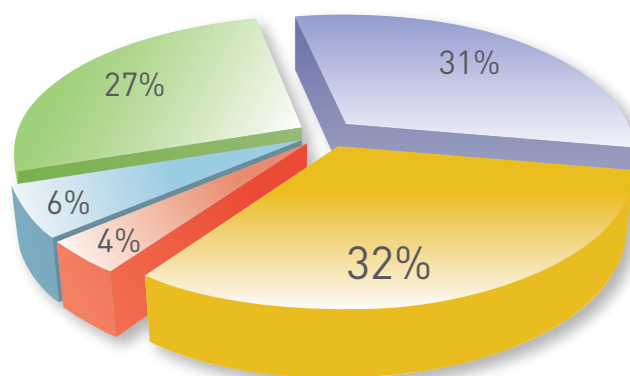

- Lighting
- Air conditioning
- Warm water
- Ventilation
- Sockets

THE ADVANTAGES OF LIGHTING MANAGEMENT IN THE COMMERCIAL SECTOR.



ENERGY SAVING

A lighting management system provides significant reduction in energy costs due to the use of artificial lighting. It is possible to reduce energy waste and automatically manage ambient lighting, taking advantage of artificial light only when necessary.



REDUCTION IN OPERATING COSTS

Operating system maintenance and management costs, as well as energy costs, are reduced significantly with an economic return on investment in the short term. Lighting management systems are among the most advantageous investments, as they pay back quickly and represent a significant gain for public and private organisations.



COMPLIANCE WITH STANDARDS

Lighting management systems ensure compliance with the EU Directives on energy efficiency for new or refurbished buildings is ensured. Consumption and operating cost reductions in line with the provisions of the Directives is not a heavy burden for the Organisation, but rather an unmissable opportunity to requalify its own structures by accessing energy efficiency classes that bring further economic value.



ENVIRONMENTAL SUSTAINABILITY

With the reduction of energy consumption, there is also an important reduction in the emission of polluting gases in the atmosphere, particularly CO₂, which is responsible for global warming. Renewable energy sources are not the only means for reaching environmental sustainability objectives: the starting point is certainly the reduction of existing consumptions, which is definitely possible when lighting management systems are implemented!

the NEW smart busbar trunking

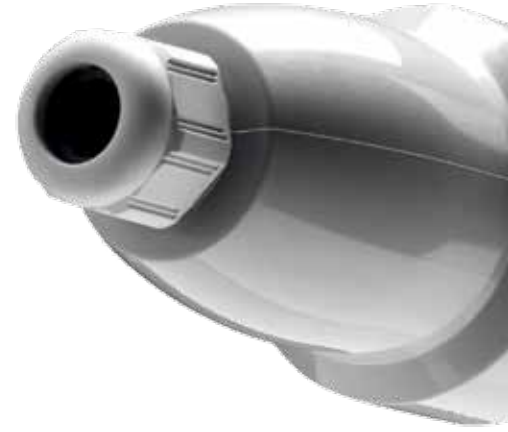

THE SAME PERFORMANCE AND ACCESSORIES

LB PLUS DATA has the same electrical and mechanical features as the standard range. It can distribute rated currents from 25 to 63A, and uses the same installation accessories as LB PLUS.

The difference with this new busbar trunking is the presence of two specific conductors, which can be used as a lighting management BUS.

LB PLUS DATA

FLEXIBILITY MEANS SAFETY

Reconfiguring a system using the LB PLUS DATA solution is easy, quick and safe. The construction characteristics ensure that whenever it is necessary to combine energy distribution with lighting management, LB PLUS DATA is the optimum solution.

NEW DEDICATED PLUGS

LB PLUS DATA has new tap-off plugs for drawing energy and for the connection of the BUS. With these new plugs, power and data can be accessed with one combined tap-off.



The tap-off plugs, identified with a yellow colour, are dedicated for the data signal.



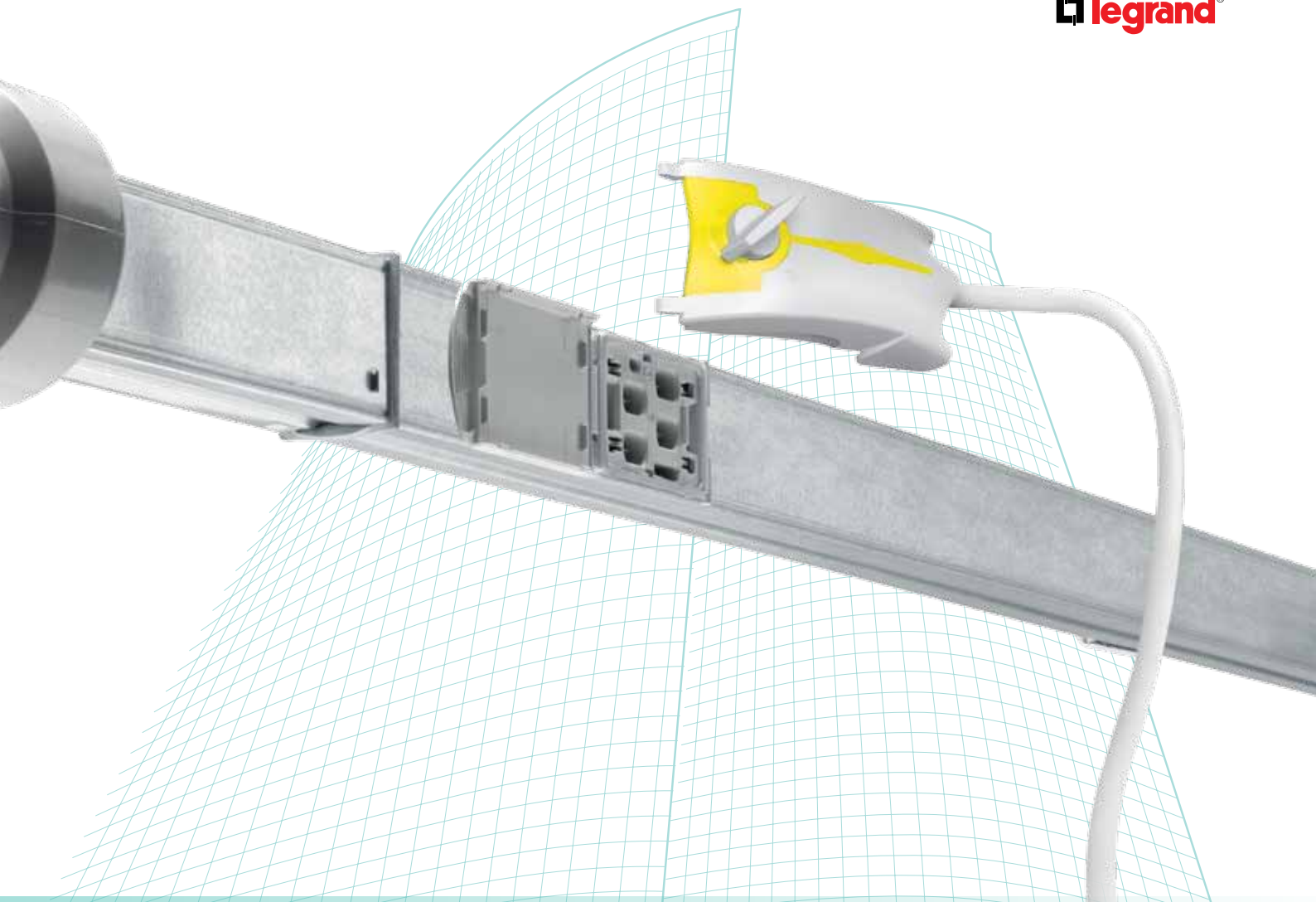

MAXIMUM FLEXIBILITY OF USE

The certified protocols that can be used with LB PLUS DATA are the DALI and the 1-10V protocols.

FULLY ADDRESSABLE DALI

All the lamps are connected to the same output of the DALI gateway and can be managed independently. It is also possible to manage all the lamps in the same way (ON, OFF, dimmed), and create independent sub-groups. The main advantage is the extreme versatility, and the configuration flexibility. This solution is suitable for offices, shopping centres with shops and display areas, supermarket corridors, and in those cases with specific lighting management and reconfiguration flexibility requirements.

BROADCAST DALI

All the lamps connected to the same DALI interface output are controlled in the same way (ON, OFF, dimmed). This does not allow single ballasts to be managed separately, and wiring groups with simplified configuration may be created. The system feedback functions are, however, maintained. This solution is suitable for installation in warehouses, or systems with corridors that do not need the management of lamp sub-groups or individual ballasts.

1-10V

This technology gives the possibility of adjusting lighting devices and dimmers using an analogue voltage signal between 1V, the minimum light level, and 10V, the maximum light level. The switching on and off of the devices is performed by adjusting the feed unit. All the lamps connected to the same 1-10V dimmer output are managed in the same way; it is not possible to have sub-groups, or to manage ballasts independently. This solution is suitable for installation in warehouses, or systems with corridors that do not need the management of lamp sub-groups or individual ballasts.

DALI is a uniform standard shared by the whole lighting sector, which defines a type of interface for digital communication between control modules and electronic feed units. Included in the EN 60929 standards, it ensures interchangeability of electronic feed units from different manufacturers. For further information on the DALI protocol visit the following website: www.dali-ag.org



the SAVINGS achievable with LB PLUS DATA

Example of installation

Below is an example of a practical application of LB PLUS DATA, with indications of the possible savings. The area of reference is a galvanic treatment area which is part of a plant of approximately 400 sqm, with skylights fitted on the roof.

GALVANIC TREATMENT AREA LAYOUT

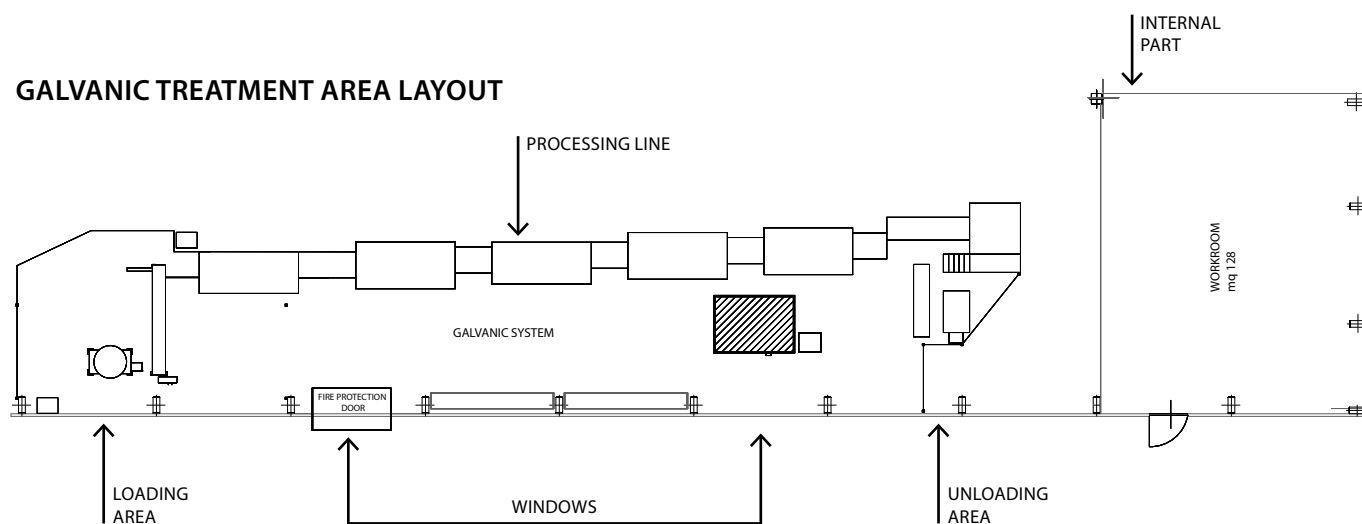

MAIN DESIGN DATA

- **Lighting system:** 3 rows of 18 lamps each. Each row is made up of 2 fluorescent tubes 80W each. Total installed power: 6.3 KW.
- **Control system:** lamps controlled by DALI ballast and connected in groups of 9 to the KNX/DALI interface, for a total of 6 groups of 9 lamps each, and each of them is connected to a different interface output.
- **Type of management:** DALI broadcast: each of the 9 lamps in each group is fully automatically controlled on the basis of movement detection and the contribution of natural light detected by the KNX sensors.

MAIN OPERATING DATA

- **Working days per year:** 240
- **Operating hours per day:** 16 (in two shifts)
- **Operations carried out:** Line load: twice a day; the whole line is illuminated for approximately 2h
Line unload: four times a day; the unloading line is illuminated for approximately 0.5h
Production: the whole line is off

EXAMPLE OF INSTALLATION DIAGRAM

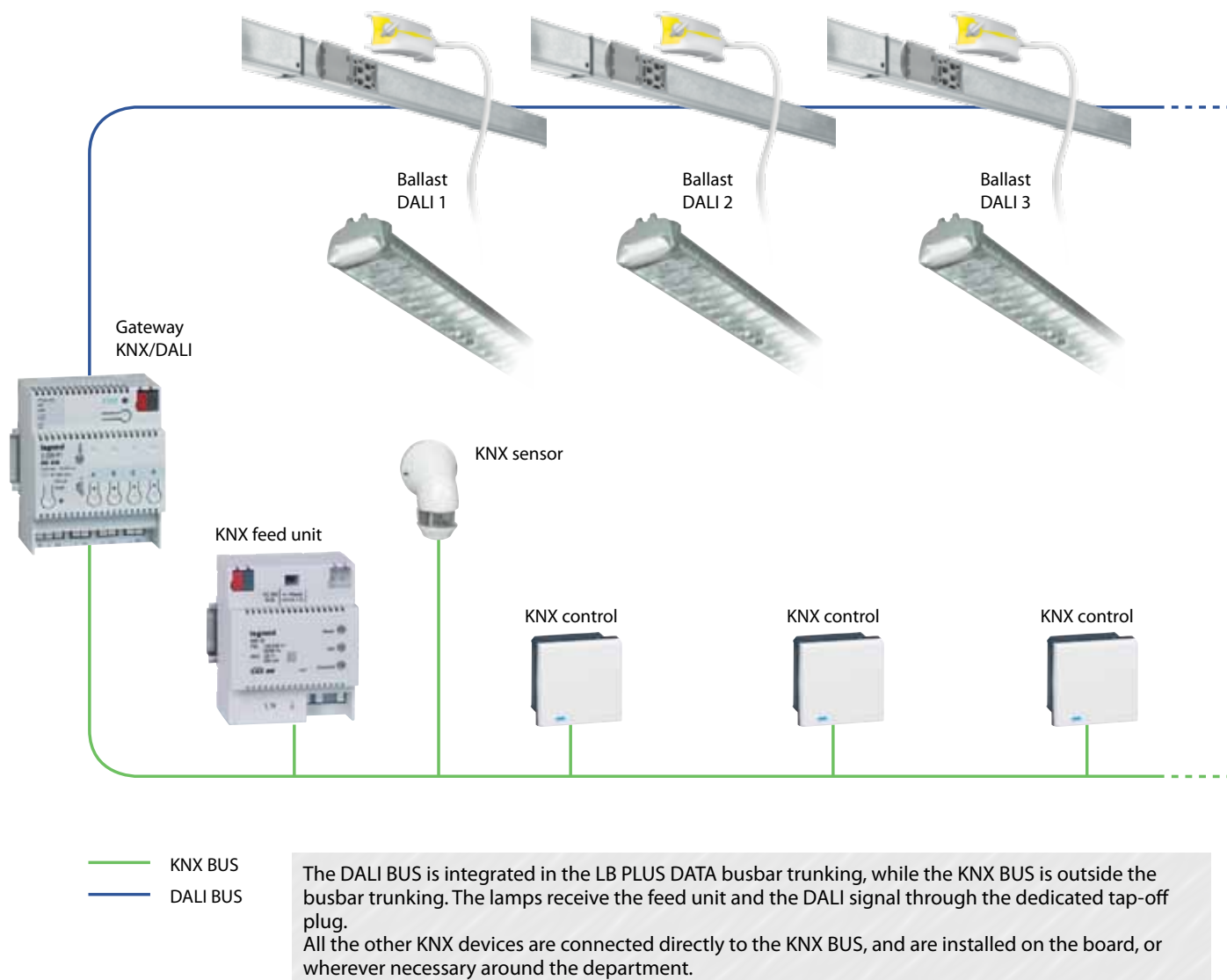

The data on energy consumption and savings that can be obtained is valid for the installation example, using the same number and the same size loads, with the type of control described, and complying with the types and times of operation described.

TYPE OF CONTROL SOLUTION	TOTAL ELECTRICITY CONSUMED IN ONE YEAR (KWH/Y)	TOTAL ELECTRICITY SAVINGS IN ONE YEAR
LB PLUS without control	19,043	-
LB PLUS DATA with broadcast KNX/DALI control	8,268	57%

By further refining the management possibilities, the implementation of a fully addressable DALI control solution **makes it possible to further maximise savings, reaching up to 61%**.

For the details of the project contact your representative.

LB PLUS DATA

In= 25-40-63 A



75160102D



75221261D

Item	STRAIGHT LENGTHS WITH BUS					
	Type	In (A)	Length (m)	Conductors	Outlets	Weight (kg)
75160102D	LBD252			2	4	3.2
75160104D					3	3.05
75170102D	LBD254	25	3	4	4+4	3.2
75170104D					3+3	3.86
75180102D	LBD256			6	4+4	3.85
75180104D					3+3	3.86
75200102D	LBD402		3	2	4	3.65
75200104D					3	3.63
75200111D		40	1.5		2	2.0
75220102D					4+4	4.8
75220104D	LBD406		3	6	3+3	4.78
75220111D					1+1	2.5
75240102D	LBD632	63	3	2	4+2	4.8
75240111D					1+1	2.5

Item	FLEXIBLE JOINTS	Weight (kg)
75201261D	25/40 A 4-conductor version	2.25
75221261D	25/40 A 8-conductor version	2.35
75241261D	63 A 4-conductor version	2.45



75161001D

75201002D

75201001D

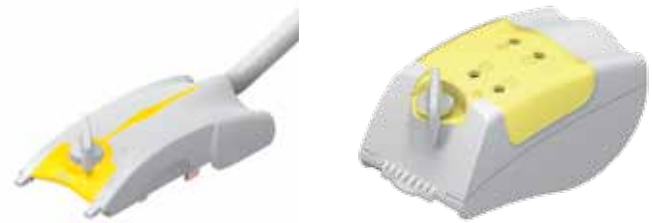

75005014D

75005008D

Item	FEED UNITS			
	Feed units can send both electricity and DATA signals through the LB PLUS cable line, they have clamps for connection to rigid or flexible copper cable with tag terminal. The end cap feed unit already includes its own closures (right feed unit + right closure, left feed unit + left closure). The centre feed unit gives the possibility of powering the busbar from the middle of the line, reducing voltage drops at the end of the line, and/or making installation easier when the electricity supply point is near the centre of the line.			
	In (A)	Conductors	Description	Weight (kg)
75161001D	25	4	RH feed unit + RH end cover	0.45
75201001D			RH feed unit + RH end cover	0.85
75201002D		4	LH feed unit + LH end cover	1.2
75201151D	40		centre feed unit*	4.0
75221001D			RH feed unit + RH end cover	0.9
75221002D		8	LH feed unit + LH end cover	1.2
75221151D			centre feed unit*	4.15
75241001D			RH feed unit + RH end cover	0.9
75241002D	63	4	LH feed unit + LH end cover	1.2
75241151D			centre feed unit*	4.25

Item	POWER AND DATA TAP-OFF PLUGS		Weight (kg)
75005005D		16 A plug with DATA BUS - cable 1 m L1-N H05VVF	0.16
75005006D		16 A plug with DATA BUS - cable 1 m L1-N FG7OM1	
75005007D		16 A plug with phase selection and DATA BUS - cable 1 m H05VVF	0.16
75005008D		16 A plug with phase selection and DATA BUS - cable 1 m FG7OM1	

TAP-OFF PLUGS WITH DATA BUS ONLY			Weight (kg)
75005014D		10 A plug DATA BUS only - cable 1 m D1-D2 H05VVF	0.16
75005064D		10 A plug DATA BUS only - cable 1 m D1-D2 FG7OM1	

* Centre feed units are supplied with both end caps (left and right).

Red codes: new items

Finishes: LB PLUS DATA in a painted version is available on request

LB PLUS DATA

Standard tap-off plugs (power only)



75005014

75005013

75005012

75005011

75005000

75007205

Item	FIXED PHASE	SINGLE PHASE TAP-OFF PLUGS	Weight (kg)
75005011	■	10 A plug with 1 m cable L1-N H05VVF	0.16
75005012	■	10 A plug with 1 m cable L2-N H05VVF	
75005013	■	10 A plug with 1 m cable L3-N H05VVF	
75005014	■	10 A plug with 1 m cable L-N2 H05VVF	
75005021	■	10 A plug with 3 m cable L1-N H05VVF	0.38
75005022	■	10 A plug with 3 m cable L2-N H05VVF	
75005023	■	10 A plug with 3 m cable L3-N H05VVF	
75005024	■	10 A plug with 3 m cable L-N2 H05VVF	
75005061	■	10 A plug with 1 m cable L1-N FG70M1	0.2
75005062	■	10 A plug with 1 m cable L2-N FG70M1	
75005063	■	10 A plug with 1 m cable L3-N FG70M1	
75005064	■	10 A plug with 1 m cable L-N2 FG70M1	
75005071	■	10 A plug with 3 m cable L1-N FG70M1	0.48
75005072	■	10 A plug with 3 m cable L2-N FG70M1	
75005073	■	10 A plug with 3 m cable L3-N FG70M1	
75005074	■	10 A plug with 3 m cable L-N2 FG70M1	

PHASE SELECTION TAP-OFF PLUGS

Item	Weight (kg)
75005000	0.12
75005100	0.13
75005200*	0.13
75005220*	0.64
75005270*	0.68

THREE-PHASE TAP-OFF PLUGS

Item	Weight (kg)
75005005	0.13
75007005	0.12
75007205*	0.12
75007206*	0.63
75007207	0.80
75007006	0.63

ACCESSORIES

75105000	16 A mobile contact
75105001	kit for the plug coding (it consists of 10 black codes for right side plugs and 10 grey codes for left side plugs and identification stickers).

Item 75005000 associated to 2 mobile contacts (75105000) gives the possibility of installing a three-phase plug (75005005).

*Fuses not supplied

Brackets and accessories

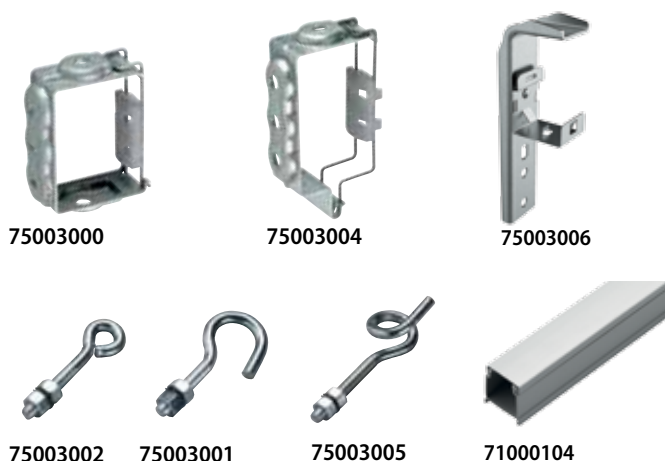

75003000

75003004

75003006

75003002

75003001

75003005

71000104

Item	BRACKETS	Weight (kg)
75003000	suspension bracket 60 kg (type A)	0.045
75003004	suspension bracket 60 kg (type B)	0.045
75003001	hook for lamp	0.015
75003002	ring	0.015
75003005	Pigtail for chain	0.015
75003008	5 m steel cable with self locking clamp	0.085
75003009	bracket with 3 m steel cable	0.05

CABLE CHANNEL FOR ADDITIONAL DATA CABLE

Item	Weight (kg)
71000104	PVC cable channel with cover (3 m)
755001	Cablofil steel wire cable tray (3 m)
75003006	bracket for cable channel

Codes **75003001-2-5** must always be used with brackets **75003000** or **75003004**, depending on the type of busbar.

Item **75003006** must always be used with brackets **75003000** or **75003004** and cable channel **71000104**.

Bracket **75003000** can be used for the suspension of the line and the suspension of lighting bodies at the same time, while bracket **75003004** may only perform one of the two functions at customer's discretion, depending on its rotation.

Red codes: new items

QUICK SELECTION TABLE

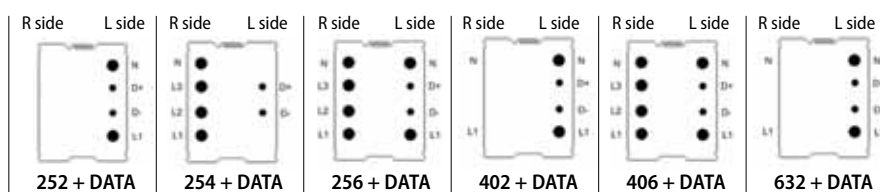

STRAIGHT LENGTHS TYPE A WITH BUS						
3m length - 4 outlets (4+4 and 4+2 outlets)	75160102D	75170102D	75180102D	75200102D	75220102D	75240102D
3m length - 3 outlets (3+3 outlets)	75160104D	75170104D	75180104D	75200104D	75220104D	
1.5m length - 1 outlets	75200111D	75220111D	75220111D	75200111D	75220111D	75240111D

FEED UNITS FOR POWER AND DATA BUS						
RH feed unit + RH end cover	75161001D	75221001D	75221001D	75201001D	75221001D	75241001D
LH feed unit + LH end cover	75201002D	75221002D	75221002D	75201002D	75221002D	75241002D
Centre feed unit	75201151D	75221151D	75221151D	75201151D	75221151D	75241151D

FLEXIBLE ELEMENTS FOR PATH CHANGE						
Flexible joint	75201261D	75221261D	75221261D	75201261D	75221261D	75241261D

POWER AND DATA TAP-OFF PLUGS						
L1-N + DATA 16A plug with 1m cable 5G1.5 (H05VVF)	75005005D				75005005D	
L1-N + DATA 16A plug with 1m cable 5G1.5 (FG7OM1)	75005006D				75005006D	
Phase selection plug + DATA 16A plug with 1m cable 5G1.5 (H05VVF)			75005007D		75005007D	
Phase selection plug + DATA 16A plug with 1m cable 5G1.5 (FG7OM1)			75005008D		75005008D	

TAP-OFF PLUGS ONLY DATA						
"DATA only" plug with 1m cable D1-D2 (H05VVF)					75005014D	
"DATA only" plug with 1m cable D1-D2 (FG7OM1)					75005064D	

BRACKETS						
Suspension bracket 60 kg (LB PLUS - TYPE A)					75003000	
Hook for lamp					75003001	
Ring					75003002	
Pigtail for chain					75003005	
Bracket for cable channel					75003006	
5m steel cable with self locking clamp					75003008	
Bracket with 3m steel cable					75003009	

GENERAL FEATURES	
In compliance with the standards	IEC 61439-6, CEI EN 61439-6
Protection index	IP55
Impact resistance	IK07
Rated current	In 25-40-63 A

STRAIGHT LENGTHS	
Material LB PLUS - TYPE A	Rigid casing (35 x 46 mm) thickness 0.5 mm
Mounting	Quick-coupling *

FEED UNITS	
Loads	In 25-40-63 A

TAP-OFF PLUGS	
Material	Self extinguishing plastic: (IEC 60695-2-12) glow wire test and V0 according to UL94
Loads	In 10-16-25 A

* with addition of screw torque

TECHNICAL DATA

LB PLUS DATA			252 DATA	254 DATA	256 DATA	402 DATA	406 DATA	632 DATA
Number of live conductors			2+2 DATA	4+2 DATA	6+2 DATA	2+2 DATA	6+2 DATA	2+2 DATA
Overall dimension of the busbar	LxH	[mm]	35x46,3	35x46,3	35x46,3	35,2x77,5	35,2x77,5	35,2x46,3
Rated current	I _n	[A]	25	25	25	40	40	63
Operational voltage	U _e	[V]	400	400	400	400	400	400
Insulation voltage	U _i	[V]	500	500	500	500	500	500
Frequency	f	[Hz]	50/60	50/60	50/60	50/60	50/60	50/60
Rated short-time current (0.1 s)	I _{cw}	[kArms]	2,2	2,2	2,2	2,7	2,7	2,7
Singlephase Peak current	I _{pk}	[kA]	4,4	4,4	4,4	5,4	5,4	5,4
Thermal limit	I ² t	[A ² s x 10 ⁶]	0,484	0,484	0,484	0,729	0,729	0,729
Phase resistance (20 °C)	R ₂₀	[mΩ/m]	4,761	4,761	4,761	4,761	3,190	1,595
Phase resistance at thermal conditions	R _t	[mΩ/m]	5,656	5,656	5,656	3,802	3,802	1,901
Phase reactance (50 Hz)	X	[mΩ/m]	0,229	0,229	0,229	0,229	0,236	0,118
Phase impedance	Z	[mΩ/m]	4,767	4,767	4,767	3,199	3,199	1,599
Resistance of protective conductor (sheet)	R _{PE}	[mΩ/m]	1,695	1,695	1,695	1,695	1,695	1,695
Reactance of the protective bar (50 Hz)	X _{PE}	[mΩ/m]	0,222	0,222	0,222	0,222	0,222	0,222
Resistance of the fault loop	R _o	[mΩ/m]	6,456	6,456	6,456	4,885	4,885	3,290
Reactance of the fault loop (50 Hz)	X _o	[mΩ/m]	0,451	0,451	0,451	0,458	0,458	0,340
Impedance of the fault loop	Z _o	[mΩ/m]	6,472	6,472	6,472	4,906	4,906	3,308
Voltage drop with distributed load	ΔV 10 ⁻⁶ cosφ = 0.7	[V/m/A]	3,03	3,03	3,03	2,08	2,08	1,04
	ΔV 10 ⁻⁶ cosφ = 0.75	[V/m/A]	3,22	3,22	3,22	2,21	2,21	1,10
	ΔV 10 ⁻⁶ cosφ = 0.8	[V/m/A]	3,42	3,42	3,42	2,33	2,33	1,17
	ΔV 10 ⁻⁶ cosφ = 0.85	[V/m/A]	3,61	3,61	3,61	2,46	2,46	1,23
	ΔV 10 ⁻⁶ cosφ = 0.9	[V/m/A]	3,80	3,80	3,80	2,58	2,58	1,29
	ΔV 10 ⁻⁶ cosφ = 0.95	[V/m/A]	3,98	3,98	3,98	2,69	2,69	1,34
	ΔV 10 ⁻⁶ cosφ = 1	[V/m/A]	4,12	4,12	4,12	2,76	2,76	1,38
Weight	p	[kg/m]	1,04	1,25	1,28	1,19	1,56	1,56
Fire load		[kWh/m]	1,03	1,91	1,91	1,0	1,9	1,9
Degree of protection	IP		55	55	55	55	55	55
Degree of impact resistance	IK		07	07	07	07	07	07
Losses for the Joule effect at nominal current	P	[W/m]	10,6	10,6	10,6	18,2	18,2	22,6
Ambient temperature min./MAX.	t [°C]		-5/+50	-5/+50	-5/+50	-5/+50	-5/+50	-5/+50

$$\Delta V1F = \frac{1}{2} (2 R_{20} \cos\varphi + 2 X \sin\varphi) \quad \Delta V3F = \frac{\sqrt{3}}{2} (R_{20} \cos\varphi + X \sin\varphi)$$

Protection from short circuit (I_n ≤ 100 A).

Zucchini busbar trunking systems with a rated current lower than or equal to 100 A (LB PLUS - MS 63 e 100) are properly protected through an MCB (Modular Circuit Breaker) with a rated current lower than or equal to that of the busbar. This protection is guaranteed up to the MCB breaking capacity.

Product fully in compliance with the standard: IEC 61439-6, CEI EN 61439-6

* metal casing

Temperature rating schedule according to the room temperature

Room temperature [°C]	15	20	25	30	35	40	45	50	55	60
K1 factor	1.15	1.12	1.08	1.05	1.025	1	0.975	0.95	0.93	0.89

Multiplier coefficient of rated current for room temperature values different from 40° C

Mechanical loads permitted table

The table shows the maximum weights (kg) that can be supported, both for concentrated, and distributed loads.

LB PLUS DATA	Distance between suspension brackets	Concentrated load	Distributed load
	1.5 m	40 kg	50 kg/m (75 kg)**
2 m	30 kg	30 kg/m (60 kg)**	
3 m	20 kg	13 kg/m (39 kg)**	

** Distributed load total weight

DIMENSIONAL DATA

LB PLUS DATA

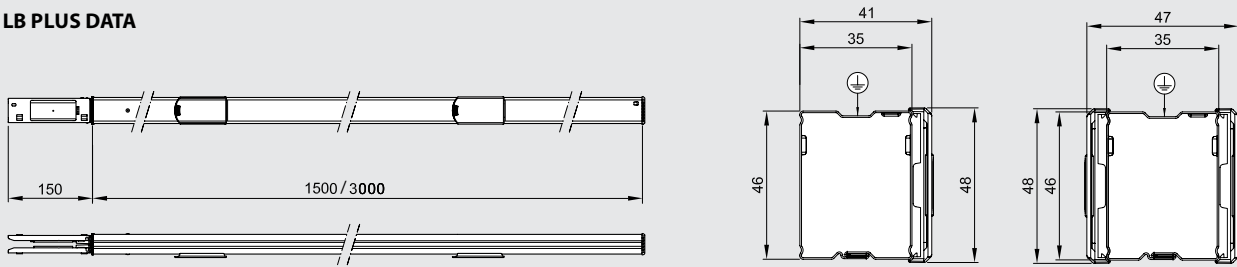

FEED UNIT 254

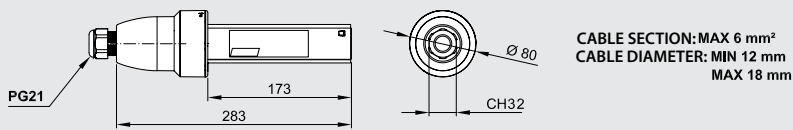

FEED UNIT 404 / 408 / 634

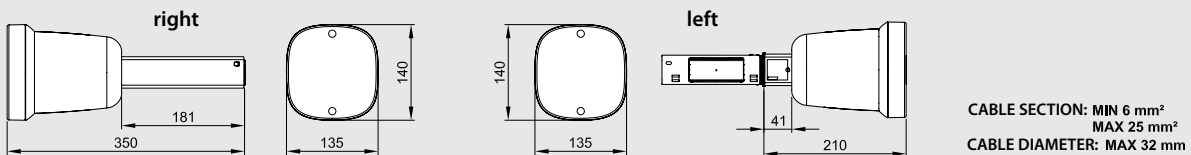

FLEXIBLE JOINT 404 / 408 / 634

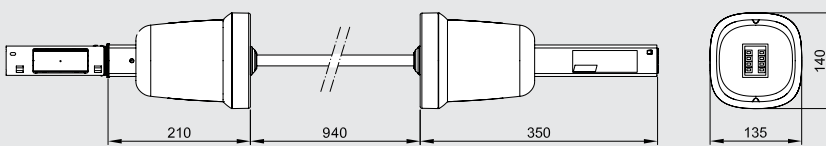

10 A PLUG

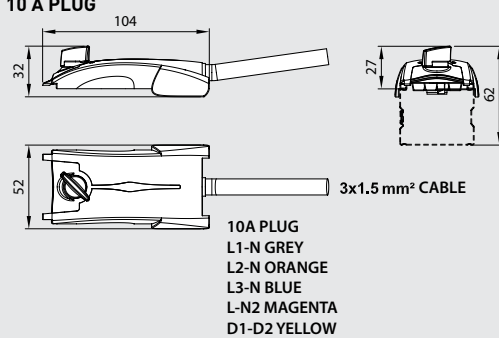

16 A PLUG

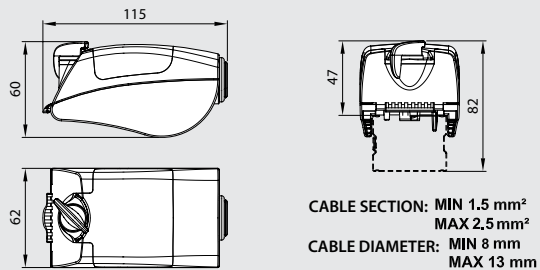

25 A PLUG

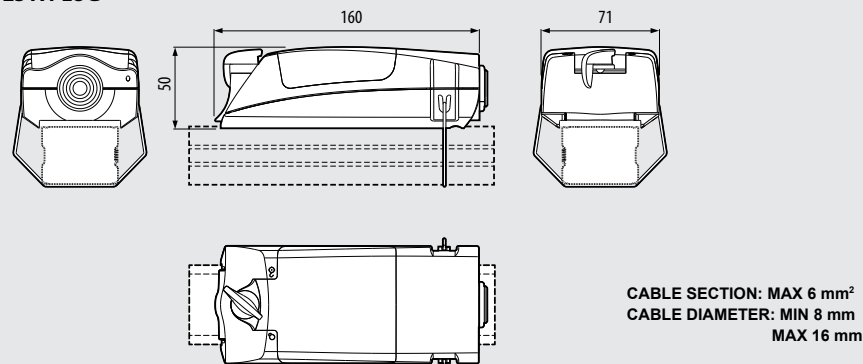

LB PLUS DATA

Lighting Management KNX



0 026 35



0 488 64



0 484 21



0 784 89



0 784 94

Item	MODULAR AND WIRE CABLE TRAY DIMMERS
0 026 35	KNX/DALI Gateway for the control of DALI ballasts, with a maximum load of 64 ballasts per output. Ballasts can be managed in different ways (individually, in groups, or all in the same way). The gateway also gives the possibility of receiving status information on ballast and DALI bus faults. Bus connection using a red-black KNX connector. Feed unit voltage 110 - 240 V 50-60 HZ, and additional feed unit from KNX bus. Fitting on DIN rail, size: 6 DIN modules
0 026 63*	KNX/DALI interface with 8 independent channels, each capable of managing up to 8 ballasts. Each ballast connected to a certain channel is managed in the same way. Bus connection using a red-black KNX connector. Feed unit voltage 110 - 240 V 50-60 HZ. Fitting on DIN rail, size: 4 DIN modules
0 488 64	KNX/DALI Room Controller. With 4 independent outputs, each capable of controlling up to 32 ballasts, 1 SCS bus input with maximum delivery 200 mA for the connection of SCS commands and sensors, and one riser KNX input with clamp connection. Bus connection using a red-black KNX connector. Feed unit voltage 100/240 Vac 50/60 Hz. False ceiling installation.
0 488 66	KNX/DALI Room Controller. Bus connection using a red-black KNX connector. Feed unit voltage 100/240 Vac 50/60 Hz. False ceiling installation.
0 488 62	KNX 1-10V Room Controller. With 4 independent outputs, each with maximum load 4.3A at 230Vac, 1 SCS bus input with maximum delivery 200 mA, for the connection of SCS commands and sensors, and one riser KNX input with clamp connection. Bus connection using a red-black KNX connector. Feed unit voltage 100/240 Vac 50/60 Hz. False ceiling installation.

Item	CONTROL DEVICES
	Directly connected to the KNX Bus (supplied with KNX connector) Programming through ETS software For lighting control (ON/OFF, dim, scenario, etc.), shutters and slats control, automation control Equipped with 4 programmable Red Green Blue LEDs (12 colours available) to indicate the status of the loads and provide system and alarm status feedback
	KNX control units - Mosaic™ Programme To be equipped with support frames and plates
0 784 89*	1 pushbutton
0 784 95*	1 actuation point 2 actuation points
0 784 94*	2 pushbuttons
0 784 96*	2 actuation points 4 actuation points
	KNX control units - Arteor To be equipped with cover plates, support frames and plates
0 675 71*	1 or 2 pushbuttons 4 actuation points
0 484 20*	2 channel KNX contact interface. It can be used for the interfacing of traditional electromechanical KNX bus controls. The 2 channels are fitted with LEDs and can be configured as inputs or outputs (status return). KNX bus connection using a red-black KNX connector. Feed unit voltage 100/240 Vac 50/60 Hz. Installation in flush-mounted box.
0 484 21*	4 channel KNX contact interface. It can be used for the interfacing of traditional electromechanical KNX bus controls. The 4 channels are fitted with LEDs and can be configured as inputs or outputs (status return). KNX bus connection using a red-black KNX connector. Feed unit voltage 100/240 Vac 50/60 Hz. Installation in flush-mounted box



0 489 21



0 489 19

Item	SENSORS
0 489 19*	Ceiling mounted KNX PIR sensor, IP20 protection index. Ideal for installation in the centre of the corridor KNX bus connection using a red-black KNX connector. SELV 29 Vdc feed unit voltage from KNX bus.support and Livinglight cover plate. Flush mounted false ceiling or masonry ceiling installation using flush mounting boxes or springs; ceiling mounted installation using accessory ref.048875
0 489 21*	Wall mounted KNX PIR sensor, IP55 protection index. Ideal for installation in open transit areas (e.g. car parks...). Bus connection using a red-black KNX connector. SELV 29 Vdc feed unit voltage from KNX bus.support and Livinglight cover plate. Wall mounted or ceiling installation.

LB PLUS DATA

Lighting Management KNX



0 035 04



0 035 16

Item	INFRASTRUCTURE DEVICES
0 035 12	<p>KNX modular feed unit Bus connection using a red-black KNX connector. Input voltage: 230V +10%...-15%, 50...60 Hz. Output voltage: 29V ±1V d.c. SELV. Output current: 320 mA. Fitting on DIN rail, size: 4 DIN modules</p>
0 035 04 *	<p>KNX modular feed unit Bus connection using a red-black KNX connector. Input voltage: 230V +10%...-15%, 50...60 Hz. Output voltage: 29V ±1V d.c. SELV. Output current: 640 mA. Fitting on DIN rail, size: 4 DIN modules</p>
0 035 16	<p>KNX coupler, to be used for data exchange between two KNX lines. It may be used as: - line coupler (to couple one line to a main line) - backbone coupler (to couple a main line to the backbone line) - repeater (to couple two segments of the same line) Connection to the bus using a red-black KNX connector. SELV 29 Vdc feed unit voltage from KNX bus.support and Livinglight cover plate. Fitting on DIN rail, size: 2 DIN modules</p>
003547	<p>KNX/USB opto-insulated interface for the connection of a PC for the addressing, parameter definition, logging display, and diagnostics of KNX systems. Fitted with type B USB connector. USB 1.1 transmission (max. 12 Mbit/s). Bus connection using a red-black KNX connector. Direct feed unit from the BUS line through USB connection. Fitting on DIN rail, size: 1 DIN modules</p>
0 492 91	<p>KNX cable with single pair of twisted conductors (red-black). It may be installed side by side with the 230 V feed unit cable and is for protruding and flush mounted installation, installation inside conduit in dry outdoor areas, provided that protection from sunlight is ensured. Test voltage: 4 kV rated diameter 6.1 mm. Length (in m): 500.</p>
0 492 92 *	<p>KNX cable with double pair of twisted conductors (red-black and white-yellow). It may be installed side by side with the 230 V feed unit cable and is indicated for protruding and flush mounted installation, for installation inside conduits, in dry outdoor areas, provided that protection from sunlight is ensured. Test voltage: 4 kV rated diameter 6.1 mm. Length (in m): 500.</p>



KNX is the world standard, compliant with the main European and international regulations, for automatic and decentralised management of technological systems in a wide range of situations: commercial buildings, industry, offices, private homes, public establishments and many more. KNX is an "open and easy to expand" system that can be used for several applications, both in the residential and service sector (e.g. lighting management, shutter and rolling shutter control, safety and heating systems etc).

KNX strongly contributes to energy savings (up to 50% in the control of lighting and heating) and to minimising the impact on the environment.

KNX holds the following approvals:

- European Standards (CENELEC EN 50090 and CEN EN 13321-1)
- International Standards (ISO/IEC 14543-3)
- Chinese Standards (GB/Z 20965)
- US Standards (ANSI/ASHRAE 135)

For further information on the KNX offer see the specific offer guide.

For further information on the KNX standard visit the following website:

www.knx.org

* for information on these items and their availability contact a Legrand representative

NOTES





FOLLOW US
AT

@ www.legrand.com

 www.youtube.com/legrand

 twitter.com/legrand



Head office
and International Department
87045 Limoges Cedex - France
Tel.: + 33 (0) 5 55 06 87 87
Fax: + 33 (0) 5 55 06 74 55